

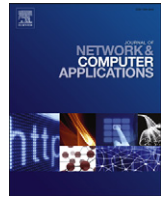

Contents lists available at SciVerse ScienceDirect

## Journal of Network and Computer Applications

journal homepage: [www.elsevier.com/locate/jnca](http://www.elsevier.com/locate/jnca)

## A comprehensive survey on vehicular Ad Hoc network

Saif Al-Sultan\*, Moath M. Al-Doori, Ali H. Al-Bayatti, Hussien Zedan

Software Technology Research Laboratory, De Montfort University, Bede Island Building, Western Boulevard, Leicester LE2 7EW, UK

## ARTICLE INFO

## Article history:

Received 20 June 2012

Received in revised form

21 February 2013

Accepted 28 February 2013

## Keywords:

VANET

Safety applications

VANET simulation

Challenges in VANET

## ABSTRACT

Vehicular ad hoc networks (VANETs) are classified as an application of mobile ad hoc network (MANET) that has the potential in improving road safety and in providing travellers comfort. Recently VANETs have emerged to turn the attention of researchers in the field of wireless and mobile communications, they differ from MANET by their architecture, challenges, characteristics and applications. In this paper we present aspects related to this field to help researchers and developers to understand and distinguish the main features surrounding VANET in one solid document, without the need to go through other relevant papers and articles starting from VANET architecture and ending up with the most appropriate simulation tools to simulate VANET protocols and applications.

© 2013 Elsevier Ltd. All rights reserved.

## 1. Introduction

At the present time cars and other private vehicles are used daily by many peoples. The biggest problem regarding the increased use of private transport is the increasing number of fatalities that occur due to accidents on the roads; the expense and related dangers have been recognised as a serious problem being confronted by modern society. VANET provides a wireless communication between moving vehicles, using a dedicated short range communication (DSRC). DSRC is essentially IEEE 802.11a amended for low overhead operation to 802.11p; the IEEE then standardises the whole communication stack by the 1609 family of standards referring to wireless access in vehicular environments (WAVE). Vehicle can communicate with other vehicles directly forming vehicle to vehicle communication (V2V) or communicate with fixed equipment next to the road, referred to as road side unit (RSU) forming vehicle to infrastructure communication (V2I) (Olariu and Weigle, 2009; Moustafa and Zhang, 2009; Jiang et al., 2006).

These types of communications allow vehicles to share different kinds of information, for example, safety information for the purpose of accident prevention, post-accident investigation or traffic jams. Other type of information can be disseminated such as traveller related information which is considered as non-safety information. The intention behind distributing and sharing this information is to provide a safety message to warn drivers about expected hazards in order to decrease the number of accidents and save people's lives, or to provide passengers with pleasant journeys.

This field attracts researchers from different fields to develop VANET applications, protocols and simulation tools. Several challenges are facing researchers and developer. Therefore, several papers and articles have tried to cover these issues. Hartenstein and Laberteaux (2008) have investigated the communication and networking aspects of this technology and addressed the security and privacy issues. While, Li and Wang (2007) focus on the routing protocols of VANET and their requirements to achieve better communication time with less consumption of network bandwidth. Lin et al. (2010) investigate the categories of routing protocols in VANET and the idea behind each of them. In this paper, we present a key document which can provide detailed information to researchers and developer so as to understand the main aspects and challenges related to VANET. It covers different issues such as network architecture, communication domains, challenges, applications and simulation tools.

The rest of this paper is structured as follows. We start in Section 2 with describing the network architecture. Section 3 presents the communication domains in VANET. In Section 4, we discuss the wireless access technologies that can be used to establish the communication of the network. Section 5 presents the unique characteristics of VANET. Network challenges and requirements are discussed in Section 6. Section 7 will give a comprehensive explanation for the applications enabled by VANET communications. VANET simulation tools are given in Section 8 before we sum up our paper with a conclusion in Section 9.

## 2. VANET architecture

The communication between vehicles, or between a vehicle and an RSU is achieved through a wireless medium called WAVE.

\* Corresponding author. Tel.: +44 7428266088; fax: +44 1162577579.

E-mail addresses: saif@dmu.ac.uk, saifalsultan@yahoo.com (S. Al-Sultan), maldoori@dmu.ac.uk (M.M. Al-Doori), alihmohd@dmu.ac.uk (A.H. Al-Bayatti), hzedan@dmu.ac.uk (H. Zedan).

This method of communication provides a wide range of information to drivers and travellers and enables safety applications to enhance road safety and provide a comfortable driving. The main system components are the application unit (AU), OBU and RSU. Typically the RSU hosts an application that provides services and the OBU is a peer device that uses the services provided. The application may reside in the RSU or in the OBU; the device that hosts the application is called the provider and the device using the application is described as the user. Each vehicle is equipped with an OBU and a set of sensors to collect and process the information then send it on as a message to other vehicles or RSUs through the wireless medium; it also carries a single or multiple AU that use the applications provided by the provider using OBU connection capabilities. The RSU can also connect to the Internet or to another server which allows AU's from multiple vehicles to connect to the Internet (C.C. Communication Consortium; Ieee Trial-use Standard for Wireless Access in Vehicular Environments; Olariu and Weigle, 2009).

### 2.1. On board unit (OBU)

An OBU is a wave device usually mounted on-board a vehicle used for exchanging information with RSUs or with other OBUs. It consists of a resource command processor (RCP), and resources include a read/write memory used to store and retrieve information, a user interface, a specialised interface to connect to other OBUs and a network device for short range wireless communication based on IEEE 802.11p radio technology. It may additionally include another network device for non-safety applications based on other radio technologies such as IEEE 802.11a/b/g/n. The OBU connects to the RSU or to other OBUs through a wireless link based on the IEEE 802.11p radio frequency channel, and is responsible for the communications with other OBUs or with RSUs; it also provides a communication services to the AU and forwards data on behalf of other OBUs on the network. The main functions of the OBU are wireless radio access, ad hoc and geographical routing, network congestion control, reliable message transfer, data security and IP mobility (C.C. Communication Consortium; Ieee trial-use standard for wireless access in vehicular environments; Olariu and Weigle, 2009).

### 2.2. Application unit (AU)

The AU is the device equipped within the vehicle that uses the applications provided by the provider using the communication capabilities of the OBU. The AU can be a dedicated device for safety applications or a normal device such as a personal digital assistant (PDA) to run the Internet, the AU can be connected to the OBU through a wired or wireless connection and may reside with the OBU in a single physical unit; the distinction between the AU and the OBU is logical. The AU communicates with the network solely via the OBU which takes responsibility for all mobility and

networking functions (C.C. communication Consortium; Olariu and Weigle, 2009).

### 2.3. Roadside unit (RSU)

The RSU is a wave device usually fixed along the road side or in dedicated locations such as at junctions or near parking spaces. The RSU is equipped with one network device for a dedicated short range communication based on IEEE 802.11p radio technology, and can also be equipped with other network devices so as to be used for the purpose of communication within the infrastructural network (Figs. 1–3).

According to C.C. Communication Consortium, the main functions and procedures associated with the RSU are:

1. Extending the communication range of the ad hoc network by re-distributing the information to other OBUs and by sending the information to other RSUs in order to forward it to other OBUs.

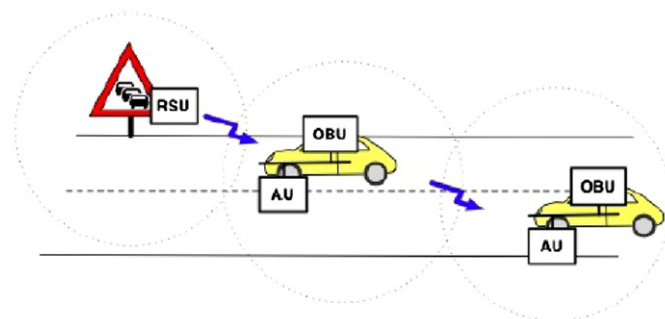

Fig. 2. RSU work as information source (running safety applications) (C.C. Communication Consortium.).

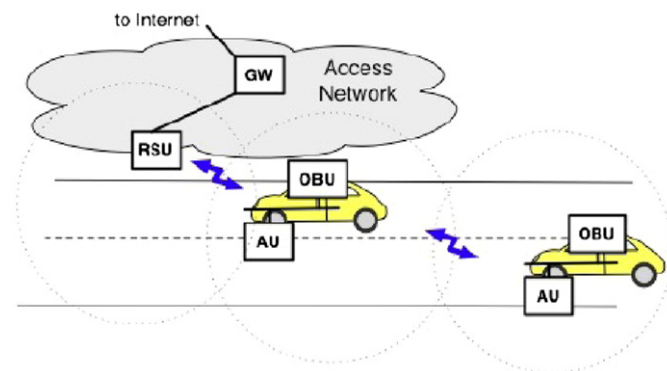

Fig. 3. RSU provides internet connectivity to the OBUs (C.C. Communication Consortium.).

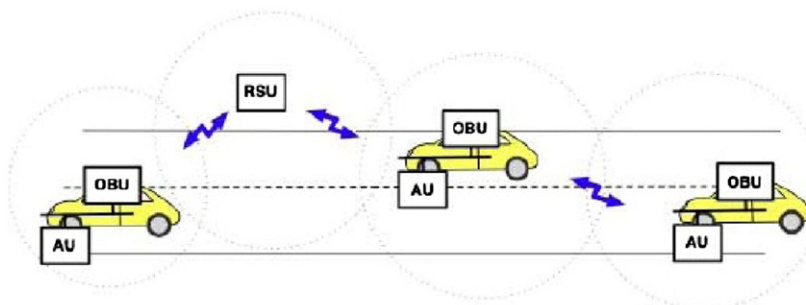

Fig. 1. RSU extend the range of the ad hoc network by forward the data of OBUs (C.C. Communication Consortium.).

2. Running safety applications such as a low bridge warning, accident warning or work zone, using infrastructure to vehicle communication (I2V) and acting as an information source.
3. Providing Internet connectivity to OBUs.

### 3. VANET communication domains

As shown in Fig. 4, the communication between vehicles and the RSU and the infrastructure form three types of domains:

1. *In-vehicle domain*: This domain consists of an OBU and one or multiple AUs. The connection could be wired or wireless using WUSB or UWB; an OBU and an AU can reside in a single device. The OBU provides a communication link to the AU in order to execute one or more of a set of applications provided by the application provider using the communication capabilities of the OBU (Olariu and Weigle, 2009; C.C. Communication Consortium; Festag et al., 2008).
2. *Ad hoc domain*: The ad hoc domain on VANET is composed of vehicles equipped with OBUs and a station along the road side, the RSU. According to Olariu and Weigle (2009), C.C. Communication Consortium, Sichitiu and Kihl (2008), Festag et al. (2008), two types of communications are available in the ad hoc domain:
  - As a component and concrete application of an ITS inter vehicle communication gained attention from researchers, academics and industry leaders, especially in US, EU and Japan. Owing to its ability to improve road traffic safety, driving efficiency and to extend on board device horizons (Luo and Hubaux, 2004), vehicles communicate with other vehicles through OUBs forming a MANET, which allows communication between vehicles in a fully distributed manner with decentralised coordination. Vehicle communicates with another vehicle directly if there is a direct wireless connection available between them, forming a

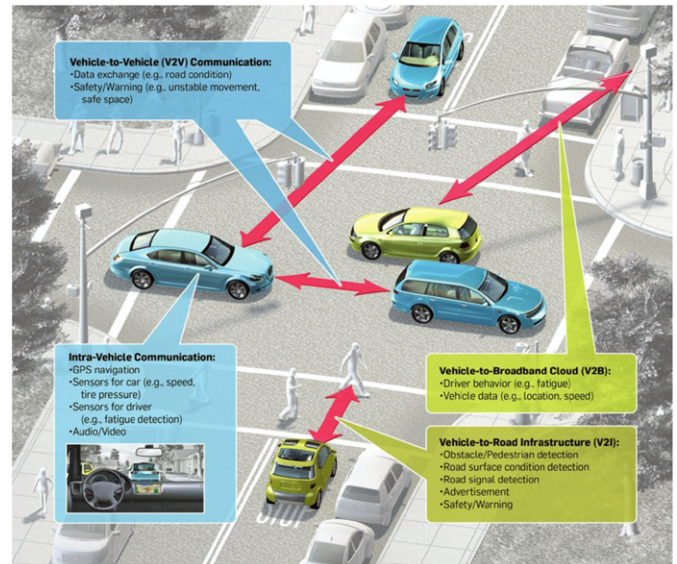

Fig. 5. Communication types in VANET (Faezipour et al., 2012).

single hop vehicle to vehicle communication (V2V); when there is no direct connection between them a dedicated routing protocol is used to forward data from one vehicle to another until it reaches the destination point, forming multi-hop vehicle to vehicle communication.

- Vehicle communicates with an RSU in order to increase the range of communication by sending, receiving and forwarding data from one node to another or to benefit from the ability of the RSU to process special applications forming vehicle to infrastructure communication (V2I).
3. *Infrastructural domain*: The RSU can connect to the infrastructural networks or to the Internet, allowing the OBU to access the infrastructure network; in this case it is possible that the AUs are registered with the OBU to connect to any internet based host. OBU can also communicate with other hosts for non-safety applications, using the communication of cellular radio networks (GSM, GPRS, UMTS, HSDPA, WiMax and 4G) (Olariu and Weigle, 2009; C.C. Communication Consortium; Festag et al., 2008).

The authors in Faezipour et al. (2012) categorised the communication types in VANET as shown in Fig. 5 into four types: intra-vehicle communication which refers to the in-vehicle domain in our classification; vehicle to vehicle communication (V2V) and vehicle to roadside infrastructure communication (V2I) which we classified them as the ad hoc domain and the last type of communications is the vehicle to broadband cloud communication where the vehicle communicate with a monitoring data centre, this type assimilate the infrastructural domain in our classification.

Our categorisation for VANET communication is more general while we referred to the communication between the vehicle and the infrastructure networks as the infrastructural domain, where the infrastructure network could be any host such as the internet and other hosts for non-safety applications.

### 4. Wireless access technology in VANET

There are numerous wireless access technologies available today, which can be used to provide the radio interface required by the vehicles in order to communicate with each other, V2V communication, or to communicate with the RSUs, V2I communication. These communication technologies intended to improve

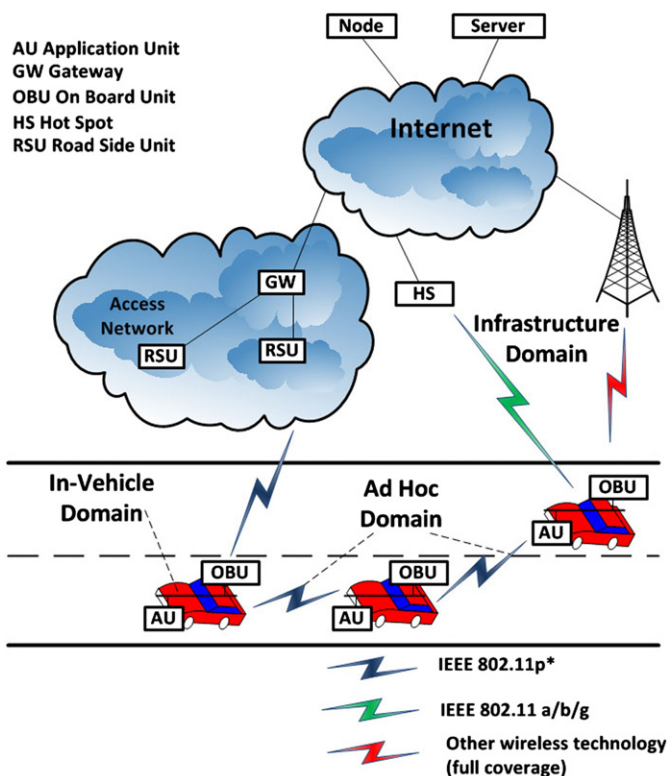

Fig. 4. Communication domains in VANET (Olariu and Weigle, 2009).

road safety, traffic efficiency and to provide driver and passenger comfort by enabling a set of safety and non-safety applications. Some of these technologies rely on a centralised infrastructure to coordinate the communications between nodes. In contrast, other technologies operate in ad hoc mode (distributed coordination) (Luo and Hubaux, 2004).

The foremost wireless access technologies are described as below:

- *Cellular systems (2/2.5/2.75/3G)*: The concept of the cellular system is to reuse the limited frequency available for the service (Rahnema, 1993). Global system for mobile (GSM) communication considered to be one of the cellular system standards that provides a data rate of a maximum of 9.6 Kbps and is characterised as a second generation (2G) (Olariu and Weigle, 2009). GSM uses both frequency division multiple access (FDMA) and time division multiple access (TDMA) schemes. Two frequency bands are available for GSM 890–915 MHz for uplink and 935–960 MHz for downlink; these frequency bands are divided into channels and the capacity of each channel is 200 kHz (Rahnema, 1993). General packet radio service (GPRS) also known as 2.5 G (Jakubiak and Koucheryavy, 2008) is an evolved version of GSM; GPRS is standardised by the European Telecommunications Standards Institute (ETSI) to accommodate data transmissions at high bandwidth efficiency, so as to enable a data rate of up to 170 Kbps (Brasche and Walke, 1997). It can work at 1710–1785 MHz for uplink and 1805–1880 MHz for downlink, further to 935–960 MHz and 890–915 MHz bands for downlinking and uplinking respectively. Enhanced Data rates for GSM Evolution (EDGE); also known as 2.75G are an evolution of GPRS which provide a peak data rate of 384 Kbps (Moustafa and Zhang, 2009). To transmit a multimedia data a high data rate is required; this led to the development of the 3G. The universal mobile telecommunication system (UMTS), and it is evolved version the high-speed downlink packet access (HSDPA), providing a data rate of up to 2 Mbps. Another comparable cellular system is the CDMA2000 which provides 3 Mbps for downlink and 1.8 Mbps for uplink (Olariu and Weigle, 2009) respectively.
- *WLAN/Wi-Fi*: Wireless local area network (WLAN) or wireless fidelity (Wi-Fi) can provide wireless access to enable V2V communication or V2I communication. IEEE 802.11 standards can be applied to provide wireless connectivity; IEEE 802.11a works at 5 GHz and provides a data rate of 54 Mbps with a communication range of at least 38 m indoor and a 140 m range for outdoor use. Another standard for IEEE 802.11 is IEEE 802.11g, which provides the same data rate and covers the same range as IEEE 802.11a but working at 2.4 GHz (Olariu and Weigle, 2009). IEEE 802.11b works at 2.4 GHz and provides a data rate of up to 11 Mbps (Moustafa and Zhang, 2009).
- *WiMAX*: Mobile–WiMAX or IEEE 802.16e is an amendment to the original worldwide interoperability for microwave access (WiMAX), or IEEE 802.16-2004, adopted by IEEE in the year 2004. IEEE 802.16e provides a high data rate and covers a wide transmission range with reliable communications and high quality of service (QoS), which makes it suitable for those applications requiring these features such as multimedia, video and voice over internet protocol (VoIP) applications. WiMAX achieves a high data rate of up to 35 Mbps using multiple-input and multiple-output (MIMO), with an orthogonal frequency division multiplexing (OFDM) and covers a transmission range of 15 Kms (Vaughan-Nichols, 2008; Bhakthavathsalam and Nayak, 2011).
- *DSRC/WAVE*: DSRC is a 75 MHz licensed spectrum at a 5.9 GHz band allocated by the US Federal Communications Commission (US FCC) in 1999, to be used solely for vehicle to vehicle

and vehicle to infrastructure communication in the United States. In Europe and Japan the spectrum is allocated at 5.8 GHz (Toor et al., 2008). DSRC radio technology is based on IEEE 802.11p, which originated from IEEE 802.11a and was amended for low overhead operation in the DSRC spectrum (Jiang et al., 2006; Jiang and Delgrossi, 2008; Moustafa and Zhang, 2009).

As shown in Fig. 6, the 75 MHz spectrum is divided into seven channels starting from channel number 172 ending with channel number 184; the capacity of each channel is 10 MHz. Channel 178 is the control channel (CCH), which is used exclusively for safety communications; channels 172 and 184 are reserved for safety applications, while the other service channels (SCH) have for both safety and non-safety uses. The whole DSRC protocol stack including IEEE 802.11p (MAC and PHY layers) standardized by the IEEE 1609 working group and called wireless access in a vehicular environment (WAVE) (Jiang et al., 2006; Jiang and Delgrossi, 2008; Moustafa and Zhang, 2009). DSRC/WAVE supports an environment in which vehicles can be moving at speeds of up to 200 Kmph, covering a communication range of 300 m and reaching up to 1000 m with a data rate of more than 27 Mbps (Jakubiak and Koucheryavy, 2008; Toor et al., 2008).

- *Combined wireless access technologies*: Continuous air interface for long and medium range (CALM M5) incorporating a set of wireless technologies including GSM-2G/GPRS-2.5G, UMTS-3G, Infrared communication and wireless systems in the 60 GHz band, adapted to IEEE 802.11p by the addition of new interface protocols (Jakubiak and Koucheryavy, 2008). As shown in Fig. 7, such technology leads to the appearance of new vehicular networking scenarios in addition to existing V2V, V2I and mixed mode (V2V and V2I), which can be achieved by using the technologies mentioned above. Peoples using smart phones that can connect to the internet can communicate with each other via the internet forming people to people (P2P) network and vehicles can communicate with each other via the internet (Olariu and Weigle, 2009).

## 5. VANET characteristics

VANET has its own unique characteristics when compared with other types of MANETs, the unique characteristics of VANET include:

1. *Predictable mobility*: VANET differs from other types of mobile ad hoc networks in which nodes move in a random way, because vehicles are constrained by road topology and layout and by the requirement to obey road signs and traffic lights and to respond to other moving vehicles (Jakubiak and Koucheryavy, 2008; Blum et al., 2004; Li and Wang, 2007; Toor et al., 2008) leading to predictability in term of their mobility.
2. *Providing safe driving, improving passenger comfort and enhancing traffic efficiency*: VANET provides direct communications among moving vehicles, thus allowing a set of applications, demanding direct communication between nodes to be applied over the network. Such applications can provide drivers travelling in the same direction with warning messages about accidents, or about the need for sudden hard breaking; leading the driver to build a broader picture of the road ahead. Moreover, additional kinds of applications could be applied via this type of network in order to improve passenger comfort and traffic efficiency by disseminating information about weather, traffic flow and point of interest information (gas station, shopping malls and fast food) (Jakubiak and Koucheryavy, 2008).

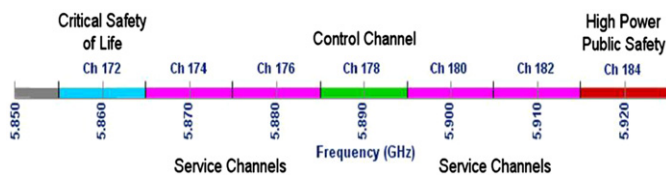

Fig. 6. 75 MHz DSRC spectrum (Jiang and Delgrossi, 2008).

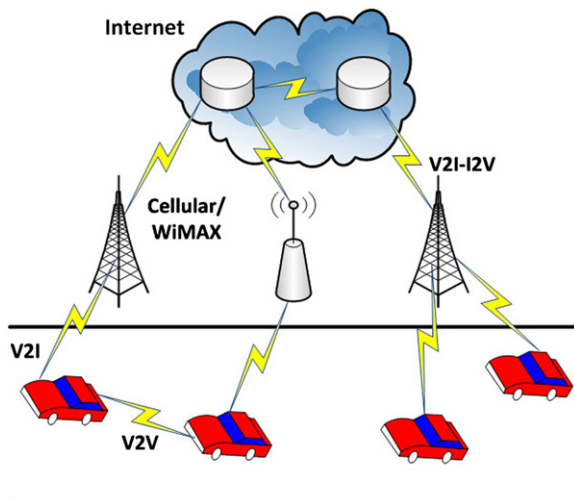

Fig. 7. Combined DSRC, Cellular, Wi-Fi and WiMAX in a single uniform (Olariu and Weigle, 2009).

3. *No power constraints*: The power in VANET is not a critical challenge as in MANETs, because vehicles have the ability to provide continuous power to the OBU via the long life battery (Jakubiak and Koucheryavy, 2008; Yousefi et al., 2006; Nekovee, 2005).
4. *Variable network density*: The network density in VANET varies depending on the traffic density, which can be very high in the case of a traffic jam, or very low, as in suburban traffic (Yousefi et al., 2006; Toor et al., 2008).
5. *Rapid changes in network topology*: High speeds typify moving vehicles, especially at the highway leading to rapid changes in network topology. Moreover, driver behaviour is affected by the necessity to react to the data received from the network, which causes changes in the network topology (Jakubiak and Koucheryavy, 2008; Yousefi et al., 2006; Li and Wang, 2007). The life time of the link between vehicles is affected by the radio communication range and the direction of the vehicles; thus increasing the radio communication range leads to an increase in the life time of the link. The life time of the link between vehicles moving in opposite directions is very short lived compared with case in which vehicles move in the same direction. The rapid changes in link connectivity cause the effective network diameter to be small, while many paths are disconnected before they can be utilised (Blum et al., 2004).
6. *Large scale network*: The network scale could be large in dense urban areas such as the city centre, highways and at the entrance of the big cities (Yousefi et al., 2006; Toor et al., 2008).
7. *High computational ability*: Because the nodes in VANET are vehicles, they can be equipped with a sufficient number of sensors and computational resources; such as processors, a large memory capacity, advanced antenna technology and global position system (GPS). These resources increase the computational capacity of the node, which help obtaining

reliable wireless communication and acquiring accurate information regarding its current position, speed and direction (Nekovee, 2005; Olariu and Weigle, 2009).

## 6. Challenges and requirements in VANET

Many issues arise when efforts are gathered towards running vehicular ad hoc networks in an attempt to provide an improvement to driver behaviour, with the aim of reducing the number of fatalities caused by automobile accidents. To realise the requirements that needed to deploy VANET concept, many factors that have a critical impact on achieving the VANET goal need to be taken into consideration, represented by safety applications and non-safety applications. Thus it is vital to specify the main important challenges in VANET, and the key challenges from the technical perspectives are as follows:

- *Signal fading*: Objects placed as obstacles between two communicating vehicles are one of the challenges that can affect the efficiency of VANET; these obstacles can be other vehicles or buildings distributed along roads especially in the cities. Their impact is placed on preventing the signal from reaching its destination and increasing the fading in the transmitted signal (Hartenstein and Laberteaux, 2008).
- *Bandwidth limitations*: Another key issue in the VANET is the absence of a central coordinator that controls the communications between nodes, and which has the responsibility of managing the bandwidth and contention operation. Therefore it is necessary to utilise the availability of bandwidth efficiently. There is a high probability that channel congestion can occur, owing to the limited range of bandwidth frequency (10–20 MHz) for VANET applications, particularly in a high density environment. The fair use of bandwidth has its impact on reducing the time delay for disseminating messages; if a vehicle needs to send a message and finds there are no opportunities for transmission, it must wait for a time to have a chance for transmission, which will have an effect on increasing the latency, especially in urban areas and with the increase in the types of application in VANET (Hartenstein and Laberteaux, 2009).
- *Connectivity*: Owing to the high mobility and rapid changes of topology, which lead to a frequent fragmentation in networks, the time duration required to elongate the life of the link communication should be as long as possible. This task can be accomplished by increasing the transmission power; however, that may lead to throughput degradation. Accordingly, connectivity is considered to be an important issue in VANET, although many studies in MANET (Blum et al., 2004; Artimy et al., 2004, 2005) have focused on solving this problem. Nevertheless, it still occupies a wide portion of the efforts gathered towards developing VANET.
- *Small effective diameter*: Owing to the small effective network diameter of a VANET, that lead to a weak connectivity in the communication between nodes. Therefore, maintaining the complete global topology of the network is impracticable for a node. The restricted effective diameter results in problems when applying existing routing algorithms to a VANET (Hartenstein and Laberteaux, 2009).
- *Security and privacy*: Keeping a reasonable balance between the security and privacy is one of the main challenges in VANET; the receipt of trustworthy information from its source is important for the receiver. However, this trusted information can violate the privacy needs of the sender (Hartenstein and Laberteaux, 2008).

- **Routing protocol:** Because of the high mobility of nodes and rapid changes of topology, designing an efficient routing protocol that can deliver a packet in a minimum period of time with few dropped packets is considered to be a critical challenge in VANET. Furthermore, many researchers have concentrated on designing a routing protocol suitable for dense environments that have a high density of vehicles with close distances between them. Designing an efficient routing protocol has an impact on improving many factors; the first of these is enhancing the reliability of the system by leveraging the percentage of packets delivery, and second by reducing the extent of interference caused by high buildings in the city environment; the third factor is that taking scalability into consideration is essential to avoid conflict, if a simultaneous operation of unicast routing request has been initiated. Another factor is to deliver a packet in the shortest possible time, especially in the emergency situation; this factor is considered to be a very critical factor (Lin et al., 2010; Chen et al., 2011; Hartenstein and Laberteaux, 2008; Yousefi et al., 2006; Zhang and Wolff, 2008; Lee et al.).

## 7. VANET applications

V2V and V2I communications allow the development of a large number of applications and can provide a wide range of information to drivers and travellers. Integrating on-board devices with the network interface, different types of sensors and GPS receivers, grant vehicles the ability to collect, process and disseminate information about itself and its environment to other vehicles in close proximity to it. That has led to enhancement of road safety and the provision of passenger comfort (Jakubiak and Koucheryavy, 2008; Wischhof et al., 2005; Toor et al., 2008).

As shown in Fig. 8, VANET applications are classified according to their primary purpose into:

- **Comfort/entertainment applications:** This category of applications is also referred to as non-safety applications, and aim to improve drivers and passengers comfort levels (make the journey more pleasant) and enhance traffic efficiency. They can provide drivers or passengers with weather and traffic information and detail the location of the nearest restaurant, petrol station or hotel and their prices. Passengers can play online games, access the internet and send or receive instant messages while the vehicle is connected to the infrastructure network (Jakubiak and Koucheryavy, 2008; Wischhof et al., 2005; Moustafa and Zhang, 2009; Toor et al., 2008).
- **Safety applications:** These applications use the wireless communication between vehicles or between vehicles and infrastructure, in order to improve road safety and avoid accidents; the intention being to save people's lives and provide a clean environment.

Safety applications have as an essential requirement for the ability to gather information through a vehicle's sensors, from other vehicles or both, in order to process and disseminate information in the form of safety messages to other vehicles or infrastructures depending on the application and its functions. Applying wireless communication technology in vehicles in order to communicate with other vehicles, or with the infrastructure, enables a wide range of applications and leads to an increase in the road safety level. It can be seen from Fig. 8, safety applications using V2V communication or V2I communication, or both can be categorised as follows (N.H.T.S. Administration, 2005):

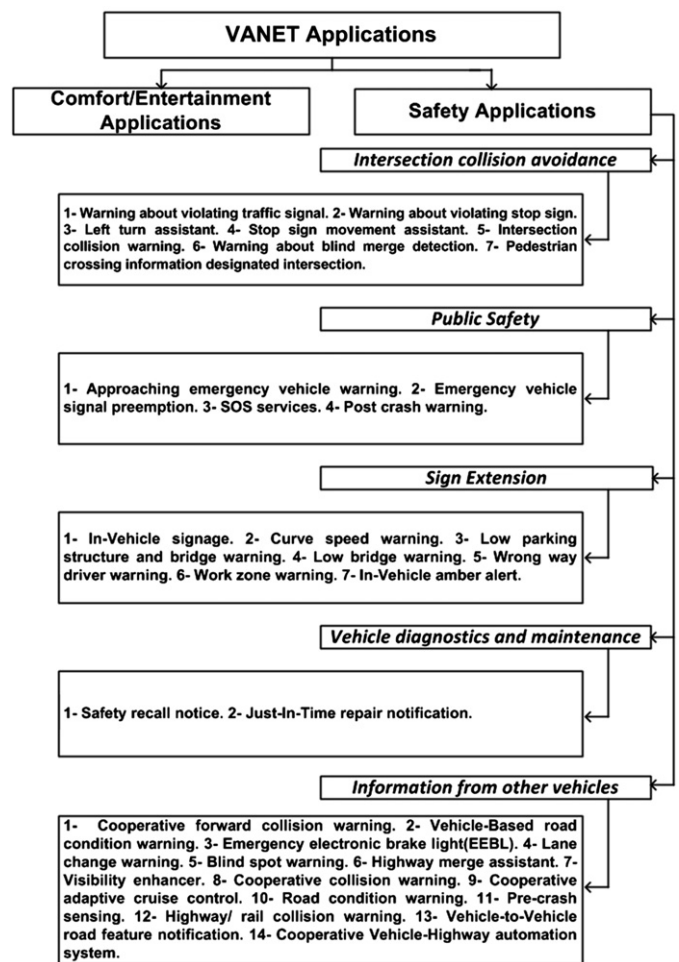

Fig. 8. VANET applications.

1. **Intersection collision avoidance:** Improving intersection collision avoidance systems will lead to the avoidance of many road accidents; this system is based on I2V or V2I communication. The sensors at infrastructure gather, process and analyse the information from the vehicles moving close to the intersection (Rawashdeh and Mahmud, 2008), depending on the analysis of data; if there is a probability of an accident or a hazardous situation, a warning message is sent to the vehicles in the intersection area to warn them about the possibility of the accident so that they can take appropriate action to avoid it. There are many applications that fall under intersection collision avoidance systems umbrella, all of them use a minimum frequency of 10 Hz, relying on I2V communication and using periodic safety messages with a communication range of 200–300 m, these applications are as follows:
  - **Warning about violating traffic signal:** This application is designed to send a warning messages to vehicles to warn the drivers about a dangerous situation (accident) that would occur happen if the vehicle does not stop; when the traffic signal is running and indicating a stop, the message that is sent depends on several factors; such as traffic status, timing, the vehicle's speed, the vehicle's position and the road surface (Rawashdeh and Mahmud, 2008; Olariu and Weigle, 2009).
  - **Warning about violating stop sign:** This application is designed to send a warning messages to a vehicles to warn the driver about the current distance between the vehicle

and the stop sign and the speed required to prevent the necessity of hard breaking, so as to prevent the vehicle from violating of a stop sign, which will then lead to the prevention of a hazardous situation (Olariu and Weigle, 2009; N.H.T.S. Administration, 2005).

- Left turn assistant: The aim of this application is to help the driver to make a left turn at an intersection in a safe way, as shown in Fig. 9 by sending the information collected about the traffic status on the opposite side of the road to the vehicle wanting to make the left turn. This information is collected by road sensors or by in-vehicle sensors and is then sent to vehicles, either directly from roadside infrastructure, or by the vehicles requesting the information via in-vehicle systems to allow the driver to decide whether turn left or not.
- Stop sign movement assistant: The aim of this application is to warn drivers about hazardous situations that may occur if their vehicles pass by an intersection. This is achieved by collecting data from road sensors and in-vehicle sensors and sending this information to the vehicles trying to pass the intersection; this means the driver will know if there are other vehicles approaching the intersection at the same time, and should lead to the prevention of accidents at intersections. This application relies on both V2V and V2I types of communications.

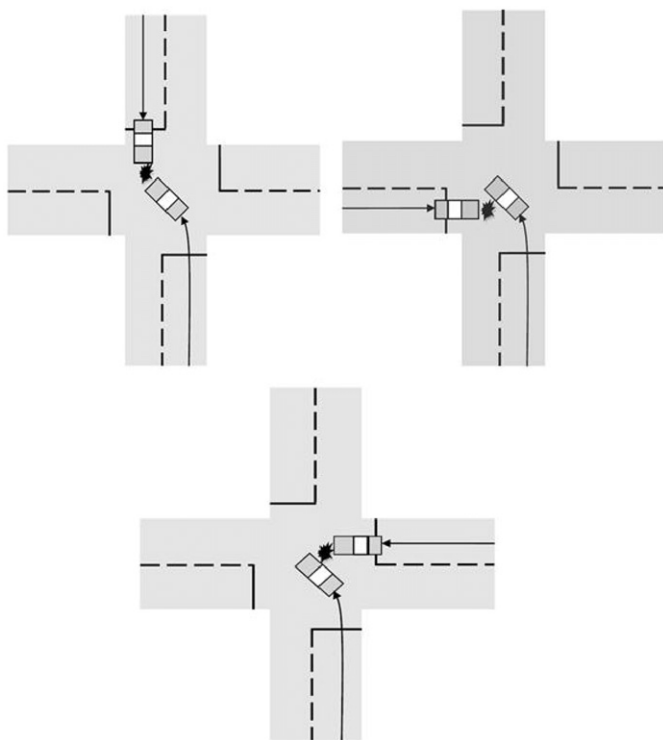

Fig. 9. Left turn driver assistant to avoid accidents (Olariu and Weigle, 2009).

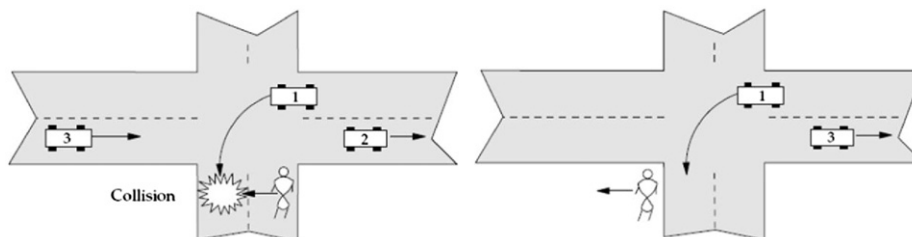

Fig. 10. Pedestrian crossing warning (Hartenstein and Laberteaux, 2009).

- Intersection collision warning: This application collects the information about the road intersection via sensors and in-vehicles sensors and analyses this information, if there is a probability of an accident occurring the system will generate and send a warning messages to all the vehicles approaching the intersection. The data gathered by the sensors includes vehicle velocity, position, acceleration and road surface information.
- Warning about blind merge detection: This application aims to prevent a collision at the merge point where the visibility is poor. The system will alert vehicles trying to merge if there is an unsafe situation, at the same time it will warn the remaining vehicles on the road. The system collects and processes the data at the intersection and if there is an unsafe situation detected it will generate a warning messages to vehicles.
- Pedestrian crossing information designated intersection: The main goal of this application is to warn drivers if there is a pedestrian crossing the road, by collecting information about the walkers via sensors installed in the walk side. After collecting this information the sensors can send it to the system; meanwhile at the same time the system has the ability to collect data if somebody has pressed the walk button located at the crossing signal, as shown in Fig. 10, after the system has processed all the data and there is a possibility of collision found it will send a warning messages to the vehicles approaching the walk side area.

2. *Public safety*: Public safety applications aim to aid drivers when an accident has occurred and to support emergency teams by minimising their travel time and provide their services, most of the emergency vehicles response time are wasted in their way to the destination. The average time for the emergency vehicle to response is 6–7 min, while in some cases this can be as much as 25 min. The frequency used by this applications is 1 Hz relying on I2V communication, V2V communication or both and using event-driven safety messages with a communication range of 300–1000 m (Olariu and Weigle, 2009).

The most familiar applications within this category are:

- Approaching emergency vehicle warning: This system is designed to satisfy the requirements to provide a clear road to allow emergency vehicles to reach their destinations without waiting in traffic, as shown in Fig. 11, the system accomplished this task by disseminating alert messages relying on one way V2V communication between vehicles travelling on the same route in an attempt to clear the road clear for the emergency vehicle, this message contains information about the emergency vehicle's velocity, direction, lane information and path.
- Emergency vehicle signal preemption: Available infrastructures at each intersection support emergency vehicles by sending messages to all traffic lights on the route to the destination using V2I communication. This sets all the lights to green when the emergency vehicle arrives at the traffic signals, minimising the response time for the

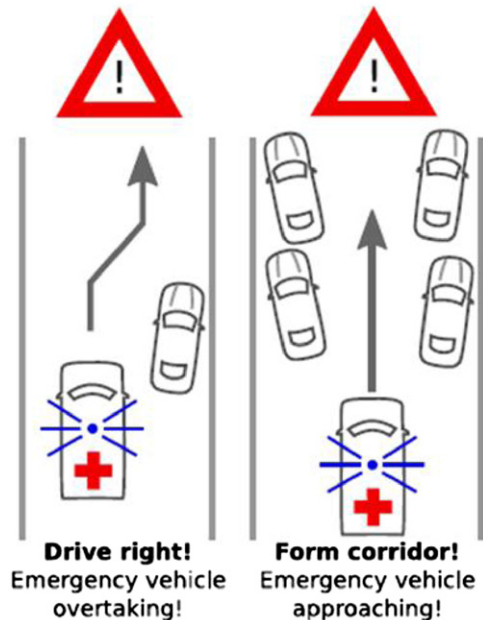

Fig. 11. Approaching emergency vehicle warning (Buchenscheit et al., 2009).

emergency vehicle, and reducing the possibility of an accident occurring involving it.

- **SOS services:** The SOS system works in conditions where a life threatening situation occurs; by sending SOS messages in the case of accidents. The SOS signal can be triggered either automatically by the system or a driver. Both types of communication (V2V and V2I) can be used to serve the system, depending on the situation for instance, the signal could be sent to the nearest infrastructure point directly, alternatively it depends upon the vehicles in range repeating the signal and delivering it to the nearest infrastructure.
  - **Post crash warning:** This application aims to prevent potential accidents before they happen; a vehicle which is disabled because of foggy weather or due to an accident sends a warning messages to other vehicles coming travelling in the same direction, or the opposite direction by using both types of communications (V2I and V2V) to inform them about its location, heading, direction and status information.
3. **Sign extension:** The main goal of this application is to alert inattentive drivers to signs that are placed on the side of the road while driving in order to prevent accidents. Most of the sign extension applications use a minimum frequency of 1 Hz relying on I2V communication and the use of periodic safety messages with a communication range of 100–500 m, these applications can be classified as follows:
- **In-vehicle signage:** This application relies on the RSU being fixed in a specific area; for example in a school zone, hospital zone or animal passing area to send alert messages to vehicles approaching the zone.
  - **Curve speed warning:** This application relies on the RSU being fixed before the curve to disseminate messages to approaching vehicles alerting them about the location of the curve, the speed required to negotiate the curve safely and the road conditions.
  - **Low parking structure and bridge warning:** This application is designed to alert the driver regarding the minimum height of the park they are trying to enter, by sending a warning messages to the vehicle via an RSU installed close to the parking facility, then the OBU can determine whether it is safe to enter the structure.

- **Low bridge warning:** This application is designed to alert the driver to the height of the bridge they are trying to pass under, by sending warning messages to the vehicle via an RSU installed close to the bridge, then the OBU can determine whether there is sufficient clearance.
  - **Wrong way driver warning:** This system is designed to alert a vehicle if it is travelling in the wrong direction. By using V2V communication a vehicle travelling the wrong way can alert the other vehicles around it via warning messages to prevent accidents occurring.
  - **Work zone warning:** This system relies on the RSU installed closed to the work zone in order to warn approaching vehicles about the work zone area, sending warning messages using I2V communication.
  - **In-vehicle Amber alert:** This system depends on I2V communication and send Amber warning messages (America's missing: broadcast emergency response) to vehicles; this messages is disseminated when the police confirm that there is a vehicle involved in the crime and it is issued to all vehicles in the area, except for the suspect vehicle.
4. **Vehicle diagnostics and maintenance:** This application aims to send notification messages to vehicles in order to remind drivers about safety defects and that it is time for the vehicle to receive maintenance.

These applications rely on I2V communication and use event-driven safety messages with a communication range of 400 m, these applications can be classified into:

- **Safety recall notice:** A message sent to vehicles to remind the drivers when a recall is issued.
  - **Just-in-time repair notification:** In this system if there is a fault within the vehicles, the OBU will send a messages to the infrastructure using V2I communication, the vehicles will receive a reply message containing instructions from the support centre to tackle this problem using I2V communication.
5. **Information from other vehicles:** This type of application relies on V2V communication, I2V communication or both to perform applications functions by a frequency of 2–50 Hz and event-driven or periodic messages requiring a communication range of 50–400 m.

Information from other vehicles applications can be classified as follows:

- **Cooperative forward collision warning:** This system accomplishes the goals necessary to assists a vehicle in avoiding becoming involved in an accident with the vehicle travelling ahead of it. The system uses V2V communication with a multi hop technique in order to send warning messages to a driver about the situation. These messages include information (position, direction, velocity and acceleration), each vehicle processes this information after receiving it to decide on the danger level then forward it to other vehicles.
- **Vehicle-based road condition warning:** This application is based on V2V communication; the vehicle collects sufficient information about the road status via the vehicle's sensors, after collecting road information the in-vehicle unit processed this data to determine the road situation in order to initiate a warning to the driver or send a warning messages to other vehicles.
- **Emergency electronic brake lights (EEBL):** This system aims to warn other vehicles on the road if there is going to be a need for sudden hard breaking or in case of foggy weather where visibility has become very poor and break lights are not bright enough to be recognised by other drivers; as shown in Fig. 12, by using only V2V communication vehicles can disseminate the message to other vehicles on the road and alert them to the need for hard breaking ahead.



- Lane change warning: As shown in Fig. 13, this application is designed to avoid crashes that might occur due to unsafe lane changing decisions being made by the driver. The system collects data about the vehicle and the surrounding vehicles; such as speed, direction and vehicle position, and when the driver decides to change his/her current lane the system processes the data collected and evaluate whether the decision will lead to an accident. The system then issues a warning to alert the driver about the potentially dangerous situation and uses V2V communication to alert other vehicles.
- Blind spot warning: This application alerts the driver if he/she decides to change lane and there is a vehicle in the

blind spot; it uses V2V communication to send a warning messages to other vehicles on the road.

- Highway merge assistant: This application prevents accidents from occurring when a vehicle is attempting to merge on the highway. If the vehicles is moving on a ramp or there are other vehicles in the vehicle's blind spot then the system start to sends a warning messages to other vehicles informing them about the speed, position and direction of the vehicle in order to take appropriate action to prevent the accident.
- Visibility enhancer: Bad weather conditions such as fog, rain and snow lead to poor visibility for the drivers, and this system assists the driver by sensing bad weather conditions and warn the driver about this conditions and warning the driver and other vehicles on the road about them.
- Cooperative collision warning: The main goal of this application is to warn the driver about any accidents that have been predicted, by relying on V2V communication. The system exchange messages between vehicles containing information about surrounding vehicles; describing their direction, position, acceleration, yaw-rate and velocity. The in-vehicle unit processes this information in combination with information about the vehicle itself; if there is a possibility of an accident the system warns the driver.
- Cooperative adaptive cruise control: This application adjusts the speed of the vehicle depending on the speed of the vehicles ahead and those behind; it uses V2V communication to exchange messages between the vehicles detailing their position, direction, speed, yaw-rate and acceleration. Meanwhile, the system utilises I2V communication to acquire the speed limit of the road.
- Road condition warning: This system is concerned with alerting vehicles about poor road conditions caused by ice or other substances causing the road to be slippery, in order to prevent accidents. The road side sensors on the system collect data regarding the road to determine if

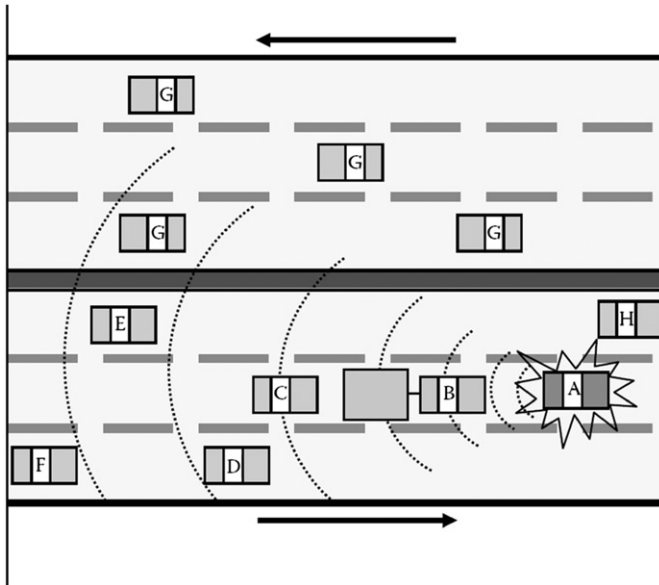

Fig. 12. Emergency electronic brake light system (Olariu and Weigle, 2009).

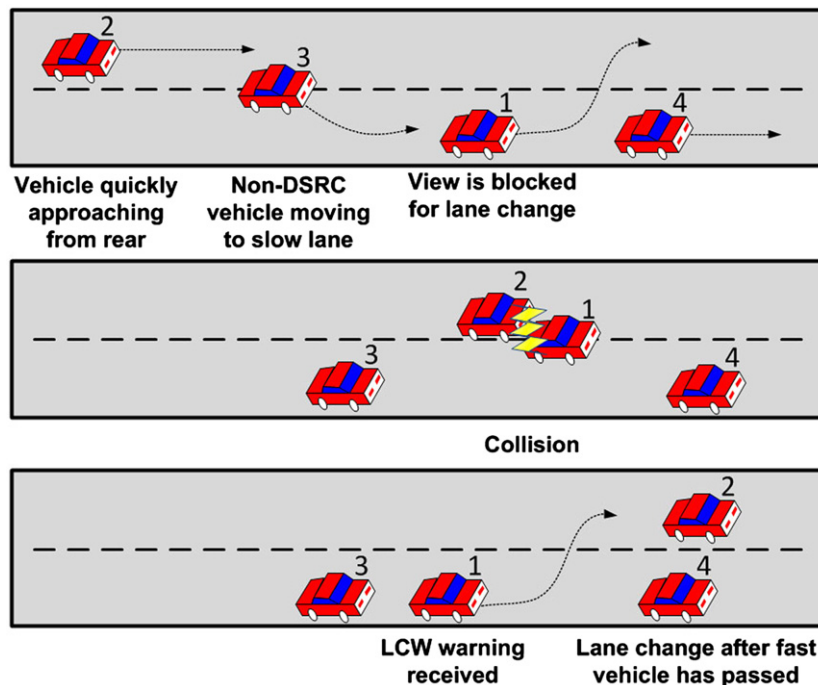

Fig. 13. Lane change warning system (Hartenstein and Laberteaux, 2009).

there are any unsafe conditions, then disseminates warning messages to vehicles to adjust, suggesting they adjust their speed to avoid accidents.

- **Pre-crash sensing:** The main goal of this system is to predict a situation in which an accident is about to happen, information can be collected from sensors, and additional data that can be acquired from other vehicles using V2V communication, this system increases the level of safety for peoples inside vehicles.
- **Highway/rail collision warning:** This application aims to prevent vehicles from becoming involved in accidents with trains, by using RSUs placed at intersections to notify approaching vehicles to prevent them colliding with trains; another method is to receive messages directly from the train to warn vehicles to take corrective action.
- **Vehicle-to-vehicle road feature notification:** This system is designed to collect information about the road infrastructure using V2V communication and disseminating this information to other vehicles on the road to be used by other VANET applications.
- **Cooperative vehicle-highway automation system:** This system controls the velocity and position of vehicles to travel on the highway as a platoon, relying on V2V communication and using V2I communication. The system collects information about the vehicle and merges the data with information regarding its position and map data in order to control the vehicle's movements and enhance the traffic flow on the highway.

There are two types of safety messages that can be disseminated by VANET safety applications (Olariu and Weigle, 2009):

1. **Periodic messages:** These types of messages contain important data used by other vehicles to take appropriate action in order to prevent unsafe situations from arising. This is done by processing the data received from the sender, which includes the vehicle's speed, current location, direction and other non-safety application data, so that vehicles can avoid any unsafe situations. Periodic messages need to be disseminated frequently containing important information for other vehicles, this may lead to waste the bandwidth allocated to wireless communication leading to the so-called 'broadcast storm' problem.
2. **Event-driven messages:** They are a high priority messages that are sent only where hazardous conditions are detected. Event-driven messages contain the location of the sender, the type of event and the time. The difficulty with event-driven messages is that the sender has to guarantee quick delivery of the message to other vehicles if they are to obtain any benefit from their content.

## 8. VANET simulation

VANET is a subclass of MANET, in which each vehicle acts as a node creating a network in the road with either another node or with a road side unit (RSU) located along the road. Each vehicle is supported with wireless sensing devices, which helps to establish communications between vehicles and RSU. This technology has been used in a range of applications such as predicting the correct route, controlling accidents and avoiding traffic jams and congestion.

In order to apply this technology to all these types of applications, the system performance needs to be tested in real life, despite the many obstacles that make this difficult such as the expense, high mobility, network complexity and distributed environments. For these reason, simulation tools are considered the best means with which to

evaluate the performance of any network type, particularly wireless and ad-hoc networks. For example, this method enables the user to emulate the network in terms of routing protocols, security constraints and other factors that are similar to real-life situations, thus avoiding the difficulties resulting from the existence of obstacles.

Compared to MANET, VANET has a number of unique characteristics, such as highly dynamic mobility and a restricted road pattern governed by roads, traffic regulations and traffic. In order to obtain an accurate result and for VANET simulations to be realistic, it is essential to generate a mobility model in order to stimulate the movement pattern of mobile vehicles.

### 8.1. Mobility model

In ad hoc networks, the regulations of node movements are determined by the mobility model, which needs to be connected with the simulator. Exploiting this knowledge enables the simulator to generate a random topology based on the circumstances of each node in the network.

The unique characteristics of VANET pose more challenges than other types of ad hoc networks. The mobility model comprises two patterns: the traffic pattern and the motion pattern. The motion pattern can be determined by the behaviour of drivers creating the vehicle movement and by pedestrians and vehicles. However, the traffic generator provides random topologies and maps and determines vehicle behaviour according to the environment. As it is difficult for the simulation model to present real-world traffic scenarios, other methods can be used to support the simulation model in its implementation. Mobility patterns may be created using different types of models depending on the situation. These types are as follows:

- **Survey models:** This type of model is based on the collected data of human behaviour and performed actions. In Vissim and Romano and Nunamaker (2001), a survey was undertaken to generate generic mobility by observing the behaviour of employees during lunchtime, break time, whilst communicating with each other and during many other activities. The UDel Models for Simulation of Urban Mobile Wireless Networks, for example, was developed for urban mesh network simulation, in which mobile nodes and obstructions can be generated in the graph.
- **Event-driven models:** These can be used for the monitoring of the movement of mobile vehicles and humans in the analysis process to obtain generated traces according to their motion and location (Tuduce and Gross, 2005; Yoon et al., 2006). The ELDA (event driven light-weight distilled state charts-based agents) (Fortino et al.) model is an example of an event-driven model based on mobile active object (MAO).
- **Software oriented models:** For this type of model, NISIM (Vissim,) and TRANSIM (Transims) may be used in the simulator. These are capable of performing traces of the urban traffic level rather than for obtaining a realistic level of detail.
- **Synthetic model:** Most of the work in this area has fallen into the category of synthetic modelling. This type of modelling is mainly based on mathematical equations in order to obtain realistic mobility models. This model comprises five main categories (Fiore):
  1. Stochastic model: depends completely on random motion.
  2. Traffic stream model: checks the mechanical features of the mobility model.
  3. Car-following model: monitors car-to-car communication behaviour.
  4. Queue model: roads are represented as queue buffers and cars are dealt within these roads.

5. Behavioural model: checks the effects of social interaction on movement.

In Hassan (2009) the author argues that the synthetic mobility model is classified based on definite criteria (the generated information level) in order to demonstrate the cons and pros of the simulator:

- *Traffic level criteria*: This level focuses on details related to streets, any obstacles that prevent vehicles in the road from communicating with each other and the density of vehicles on roads. In order to obtain these details, some traces need to be acquired such as start and end points, topology, vehicle velocity and path selection.
- *Motion level*: This level establishes the topology between vehicles in the network and analyses their behaviour based on information collected at the traffic level. It also defines a pattern of human behaviour.

## 8.2. Simulation evaluation

It is important to evaluate the performance of any network in order to highlight any issues that may exist; the most appropriate way to accomplish this task is therefore to deploy simulations that provide the closest results to real-world observations.

Various simulation tools have been used to evaluate and simulate the performance of routing protocols in VANET, for example, [The Network Simulator—ns-2](#) and [Global mobile information system simulation glomosim](#). Either C++ or the Java programming languages are used to build the simulators; some other approaches have also been tested using self-developed codes.

### 8.2.1. Network simulator (NS2 and NS3)

The University of California at Berkeley and the VINT project have developed the NS-2, a discrete event and an object-oriented simulator designed for networking research. Several different NS-2 versions have been released over the last few years; the latest version is the NS-2.34. The NS-2 provides significant support for the simulation of TCP, routing and multicast protocols over wired and wireless networks.

Using OTcl scripts facility programming enables a specific network topology to be declared. The application and protocols that need to be simulated can be achieved, as can a determination of how to define the final format of the output obtained. The application of an OTcl linkage enables the objects compiled in C++ to be used. From the user's perspective, the NS-2 can therefore be entered using the OTcl scripts as input commands into the interpreter, obtaining output in the form of trace files.

The NS-2 simulator is written in C++ with an OTcl (Object Tool Command Language) interpreter as a command and configuration interface. C++ is fast to run but slower to change, making it appropriate for use in comprehensive protocol implementation. In contrast, the OTcl part, which runs much more slowly but can be changed very quickly, is used for the simulation configuration. The split-language programming approach allows for the rapid generation of large scenarios, which is considered to be one of the advantages of the NS-2 simulator (Al-Doori, 2011).

Some limitations can be found in NS2 in terms of the type of antenna supported. NS2 can support only the bi-directional and omnidirectional antenna. In addition, the node needs to be programmed manually to find nodes that are moving around and which send and receive data to each other. NS3 appears to provide an improvement in this respect. It is exclusively written in C++ and it is available for different platform such as Windows, Linux, Unix and OS X, with the coding limited to only a few

hundred lines as opposed to 300,000 lines for NS-2. For the sake of huge network simulation, NS3 has come to support distributed and federated simulation tasks.

NS-3 is a free software available for researchers and developers in order to simulate internet protocols and huge systems in a controlled environment. NS-3 is differ from NS-2 in several features. It is developed to enhance the scalability and the modularity by providing an optional Python scripting interface, it provides an architecture to integrate several open source software, for example, kernel protocol stacks.

### 8.2.2. GlomoSim

The global mobile information system simulator is the most popular network simulator after NS2. GlomoSim was developed in California, USA to simulate wireless network simulation. It was coded in Parsec, in which all new protocols need to be defined (Bagrodia et al., 1998). GlomoSim has the ability to run on SMP (shared-memory symmetric processor: memory simultaneously accessible by all programs) and to assist in dividing the network into separate modules, each running as a distinct process. This decreases the load on the CPU by dividing its workload. GlomoSim supports multiple wireless technologies including IEEE802.11e (Farooq and Rauf).

GlomoSim was developed to support million of nodes as a single simulation. Node and layer aggregation are considered to be a limitation in many network simulators, but this feature is provided in GlomoSim.

GlomoSim version 2.0 was released in 2000. Following its release, PARSEC stopped working on freeware and released a commercial version of GlomoSim called QualNet.

### 8.2.3. MOVE

The mobility model generator for vehicular networks is based on the Java programming language and is built on SUMO ([Simulation of urban mobility](#)). MOVE has greater consideration of traffic levels supported by GUI facilities.

Mobility trace files can be generated from the Google Earth or TIGER databases. Custom (random and user) graphs are also supported, although the node movement is constrained to a grid in a random graph. MOVE is not yet capable of simulating networks, but parses files of traces to be subsequently processed by a network simulator (Karnadi et al., 2007).

### 8.2.4. TraNs

TraNs (traffic and network simulator environment) is based on Java with a visualisation tool to integrate SUMO and NS-2 and is specially designed for VANET ([Traffic and network simulation environment](#)). A separate version, called TraNs Lite, has been built for mobility model generation only without using integrated NS-2 simulators for network simulation. TraNs Lite is able to support up to 3000 nodes and can take mobility traces from the TIGER database or by using shape files (a vector map).

The integrated facility provided by TraNs enables the two well-known simulators SUMO and NS-2 to be combined in a single module to support vehicular simulation. This can be accomplished by converting traffic files into a dump file by SUMO. This file can then be read by NS-2. The only limitation is that the file obtained from NS-2 cannot be returned back to SUMO, which leads to both simulators together failing to produce a simulation similar to real life.

### 8.2.5. VANET MobiSim

VANET MobiSim was developed to overcome the limitations of CanuMobiSim. It supports car-to-car and car-to-infrastructure communications, which support stop signs, traffic lights and activities

based macro-mobility with the support of human mobility dynamics. TIGER, GDF and random and custom topology are used to obtain road and traffic topology. VanetMobiSim uses a parser to obtain the topology from GDF or TIGER.

The drawback of VanetMobiSim is that it cannot return back any feedback. For example, the trace files obtained from VanetMobiSim are parsed and then sent to the network simulator, but no feedback can be obtained.

### 8.2.6. NCTUns

NCTUns (National Chiao Tung University Network Simulator) (Wang and Lin, 2008) is built using C++ programming language with a high level of GUI support. The user has less need to be concerned about code complexity. NCTUns combines the traffic and network simulators in a single module, making a distinct vehicular network environment available.

NCTUns supports the ITS (intelligent transport system) environment by using automatic road assignment supported by the SHARPE-format map file. Vehicle movement can be controlled automatically. Use of GUI support in NCTUns helps to deploy vehicles automatically and in a less complex way. From the network side, NCTUns can simulate 802.11a, 802.11b, 802.11g and 802.11 technologies. NCTUns includes directional, bidirectional and omnidirectional antenna.

Compared to TraNs, NCTUns combines traffic and network simulators together in a single module and returns feedback to support VANET. However, the maximum number of nodes that can be supported by NCTUns is just 4096.

## 9. Conclusion

This paper provides a comprehensive survey dealing with all the issues facing VANET, in particular, VANET architectures components, VANET communication domains, wireless access technologies, VANET characteristics, challenges and requirements, VANET applications and simulation tools. This investigation enables researchers to focus on the issues surrounding VANET and its applications, showing great deal of understanding of how to tackle all issues related to VANET i.e. What architecture component to focus on? What access technology to use? What kind of applications is the new paradigm? And what simulation tool should be the appropriate model to evaluate and implement available approaches. No ultimate answer or platform could be provided from this study, because of the uniqueness each individual case holds. Each scenario holds its own features, criteria and requirements; as an answer, this paper aims to provide the key concepts to undertake all question and concerns ITS researchers are facing.

## References

N.H.T.S. Administration. Vehicle safety communications project task 3 final report, identify intelligent vehicle safety applications enabled by dsrc. Technical Report, US Department of Transportation. Technical Report DOT HS 809 859 2005.

Al-Doori M. Directional routing techniques in vanet. PhD thesis; November 2011.

Artimy M, Robertson W, Phillips W. Connectivity in inter-vehicle ad hoc networks. In: Canadian conference on electrical and computer engineering, IEEE, vol. 1; 2004. p. 293–8.

Artimy M, Phillips W, Robertson W. Connectivity with static transmission range in vehicular ad hoc networks. In: Proceedings of the 3rd annual communication networks and services research conference. IEEE; 2005. p. 237–42.

Bagrodia R, Meyer R, Takai M, Chen Y-A, Zeng X, Martin J, Song HY. Parsec: a parallel simulation environment for complex systems. Computer 1998;31(10):77–85. <http://dx.doi.org/10.1109/2.722293>.

Bhakthavathsalam R, Nayak S. Operational inferences on vanets in 802.16e and 802.11p with improved performance by congestion alert. In: Consumer communications and networking conference (CCNC), 2011 IEEE; 2011. p. 467–71.

Blum J, Eskandarian A, Hoffman L. Challenges of intervehicle ad hoc networks. IEEE Transactions on Intelligent Transportation Systems 2004;5(4):347–51.

Brasche G, Walke B. Concepts, services, and protocols of the new gsm phase 2+ general packet radio service. IEEE Communications Magazine 1997;35(8):94–104.

Buchenscheit A, Schaub F, Kargl F, Weber M. A vanet-based emergency vehicle warning system. In: Vehicular networking conference (VNC), IEEE, IEEE, 2009; 2009. p. 1–8.

C.C. Communication Consortium. Car 2 car communication consortium manifesto. (<http://car-to-car.org/index.php?id=31>).

Chen W, Guha R, Kwon T, Lee J, Hsu Y. A survey and challenges in routing and data dissemination in vehicular ad hoc networks. Wireless Communications and Mobile Computing 2011;11(7):787–95.

Faezipour M, Nourani M, Saeed A, Addepalli S. Progress and challenges in intelligent vehicle area networks. Communications of the ACM 2012;55(2):90–100 <http://dx.doi.org/10.1145/2076450.2076470> URL: (<http://doi.acm.org/10.1145/2076450.2076470>).

Farooq J, Rauf B. Implementation and evaluation of ieee 802.11 e wireless lan in glomosim, Department of Computing Science Umeå University Sweden.

Festag A, Noecker G, Strassberger M, Lubke A, Bochow B, Torrent-Moreno M, Schnauffer S, Eigner R, Catrinescu C, Kunisch J. Now-network on wheels: project objectives, technology and achievements. In: Proceedings of the 5th international workshop on intelligent transportation; 2008. p. 211–6.

Fiore M. Mobility models in inter-vehicle communications literature. Technical Report, Department of Electronics, Polytechnic Institute of Torino.

Fortino G, Garro A, Masciullo S, Russo W. Modeling multi-agent systems through event-driven lightweight dsc-based agents, Università della Calabria, Via P. Bucci cubo 41c 87036.

Global Mobile Information System Simulation glomosim. (<http://pcl.cs.ucla.edu/projects/glomosim/>) [accessed: 21/02/2012].

Hartenstein H, Laberteaux KP. A tutorial survey on vehicular ad hoc networks. Communications Magazine, IEEE 2008;46(6):164–71.

Hartenstein H, Laberteaux K. VANET vehicular applications and inter-networking technologies. Wiley Online Library; 2009.

Hassan A. Vanet simulation, Master thesis; May 2009.

IEEE Trial-use Standard for Wireless Access in Vehicular Environments (wave)—Resource Manager. IEEE Std 1609.1-2006 (2006) c1–63. <http://dx.doi.org/10.1109/IEEESTD.2006.246485>.

Jakubiak J, Koucheryav Y. State of the art and research challenges for vanets. In: Consumer communications and networking conference. CCNC 2008. 5th IEEE; 2008. p. 912–6.

Jiang D, Delgrossi L. IEEE 802.11p: towards an international standard for wireless access in vehicular environments. In: Vehicular technology conference. VTC Spring 2008. IEEE; 2008. p. 2036–40.

Jiang D, Taliwal V, Meier A, Holfelder W, Herrtwich R. Design of 5.9 Ghz dsrc-based vehicular safety communication. IEEE Wireless Communications 2006;13(5):36–43 [see also IEEE Personal Communications].

Karnadi F, Mo ZH, Chan Lan K. Rapid generation of realistic mobility models for vanet. In: Wireless communications and networking conference. WCNC 2007. IEEE; 2007. p. 2506–11. <http://dx.doi.org/10.1109/WCNC.2007.467>.

Lee K, Lee U, Gerla M. Survey of routing protocols in vehicular ad hoc networks. Advances in vehicular ad-hoc networks: developments and challenges, IGI Global.

Li F, Wang Y. Routing in vehicular ad hoc networks: a survey. IEEE Vehicular Technology Magazine 2007;2(2):12–22.

Lin Y, Chen Y, Lee S. Routing protocols in vehicular ad hoc networks: a survey and future perspectives. Journal of Information Science and Engineering 2010;26(3):913–32.

Luo J, Hubaux J-P. A survey of inter-vehicle communication. Technical Report, School of Computer and Communication Sciences. EPFL, Lausanne, Switzerland. Technical Report IC/2004/24; 2004.

Moustafa H, Zhang Y. Vehicular networks: techniques, standards, and applications. CRC Press; 2009.

Nekovee M. Sensor networks on the road: the promises and challenges of vehicular ad hoc networks and grids. In: Workshop on ubiquitous computing and e-Research; 2005.

Olariu S, Weigle MC. Vehicular networks: from theory to practice. 1st ed. Chapman & Hall/CRC; 2009.

Rahnema M. Overview of the gsm system and protocol architecture. IEEE Communications Magazine 1993;31(4):92–100.

Rawashdeh Z, Mahmud S. Intersection collision avoidance system architecture. In: Consumer communications and networking conference, CCNC 2008. 5th IEEE, IEEE; 2008. p. 493–4.

Romano NC, Nunamaker JF. Meeting analysis: findings from research and practice. In: Proceedings of the 34th annual Hawaii international conference on system science; 2001. p. 13. <http://dx.doi.org/10.1109/HICSS.2001.926253>.

Sichitiu M, Kihl M. Inter-vehicle communication systems: a survey. IEEE Communications Surveys & Tutorials 2008;10(2):88–105.

Simulation of Urban Mobility. (<http://sumo.sourceforge.net/>) [accessed: 21/05/2012].

The Network Simulator—ns-2. (<http://www.isi.edu/nsnam/ns/>) accessed: 21/05/2012.

Toor Y, Muhlethaler P, Laouiti A. Vehicle ad hoc networks: applications and related technical issues. IEEE Communications Surveys Tutorials 2008;10(3):74–88.

Traffic and Network Simulation Environment. (<http://lca.epfl.ch/projects/trans/>) [accessed: 21/05/2012].

Transims. (<http://transims.tsasa.lanl.gov/>) [accessed: 21/02/2012].

- Tuduce C, Gross T. A mobility model based on wlan traces and its validation. In: INFOCOM 2005. 24th annual joint conference of the IEEE computer and communications societies. Proceedings of the IEEE, vol. 1; 2005. p. 664–74. <http://dx.doi.org/10.1109/INFCOM.2005.1497932>.
- UDeL Models for Simulation of Urban Mobile Wireless Networks. (<http://udelmodels.eecis.udel.edu/>) [accessed: 30/04/2012].
- VanetMobiSim. (<http://vanet.eurecom.fr/>) [accessed: 21/05/2012].
- Vaughan-Nichols S. Mobile wimax: the next wireless battle ground. *Computer* 2008;41(6):16–8, <http://dx.doi.org/10.1109/MC.2008.201>.
- Vissim. (<http://www.english.ptv.de/cgi-bin/traffic/trafvissim.pl>) [accessed: 22/02/2012].
- Wang S-Y, Lin C-C. Nctuns 5.0: a network simulator for ieee 802.11(p) and 1609 wireless vehicular network researches. In: Vehicular technology conference. VTC 2008-Fall. IEEE 68th; 2008. p. 1–2. <http://dx.doi.org/10.1109/VETEFC.2008.464>.
- Wischhof L, Ebner A, Rohling H. Information dissemination in self-organizing intervehicle networks. *IEEE Transactions on Intelligent Transportation Systems* 2005;6(1):90–101.
- Yoon J, Noble B, Liu M, Kim M. Building realistic mobility models from coarse-grained traces. In: Proceedings of the 4th international conference on mobile systems, applications and services, ACM; 2006. p. 177–90.
- Yousefi S, Mousavi MS, Fathy M. Vehicular ad hoc networks (vanets): challenges and perspectives. In: Proceedings of the 6th international conference on ITS telecommunications; 2006. p. 761–6.
- Zhang M, Wolff R. Routing protocols for vehicular ad hoc networks in rural areas. *IEEE Communications Magazine* 2008;46(11):126–31.