

Research Article

# Real Time Safeguard of Workers in Coal Mining using Wireless Sensor Networks and RFID

Raghu Teja\*, N. Madhu† and Polaiah Bojja†

†Department of ECE, Vardhaman Engineering College, Hyderabad, Telangana state, India

Accepted 31 July 2015, Available online 02 Aug 2015, Vol.5, No.4 (Aug 2015)

## Abstract

*At present, environmental monitoring system of mine is widely used in industrial bus, to connect underground monitoring system with ground information center by cable or fiber optic to constitute a wire monitoring network. But it always exists cabling problems. In this project mine environment monitoring system Based on wireless sensor networks (WSNs) using ZigBee is designed. In this project we can monitor the temperature of the mine by using a temperature sensor, humidity of the mine by using humidity sensor, and also the level of carbon monoxide by using gas sensor. In order to give proper security to mine, we are giving an ID card to the miners. To get the immediate emergency services connecting GSM to the server to send the message to fire and hospitals departments.*

**Keywords:** WSN, ARM lpc2148, sensor.

## 1. Introduction

Environmental monitoring system of mine is widely used in industrial bus, to connect underground monitoring system with ground information center by cable or fiber optic to constitute a wire monitoring network. But it always exists cabling problems. WSN is a technology which is based on low-power wireless communication technology, embedded computing, micro-sensor technology and integrated circuit technology. It is an intelligent network system [S., Malaric, 2006] that is widely distributed in certain region, concluding a large number small sensor node which has wireless communication and computing abilities and could independently complete the assigned tasks by self organization according to the environment. WSNs have some characteristics of non-center, self-organization, dynamic topology, and numbers of nodes, high density, and limited hardware resources. These make WSNs have a good potential in the environmental monitoring, medical care, military and so on. The mine environment monitoring system based on WSNs can solve the problem of routing and can achieve the monitoring of multi-point to multipoint. In this proposed project, a remote mine environment monitoring system Based on wireless sensor networks (WSNs) using ZigBee is designed. The wireless part of the underground will be having the sensors for collecting the information. Sensor nodes are responsible for the collection of environmental

parameters, and sending the collected data. Sensor nodes were arranged under tungsten mine flexibly.

It transferred various safety indicators within the mine to the controller section, and then via transmission network uploaded the data to the ground monitoring center by the Zigbee communication. ARM Micro-processor module is the computer controlling core of WSNs nodes in this proposed mine monitoring system. Collecting signals of environment parameters needed high sampling rate and large data volume, which was decisive in node design. So its processor should meet small volume, high integration, low consumption and high performance. In order to improve the security inside the mine, Radio Frequency based ID card is used by the labours to for access. To get the immediate emergency services connecting GSM to the server to send the message to fire and hospitals departments.

## 2. Architecture

### ARM core

The ARM7 family includes the ARM7TDMI, ARM7TDMI-S, ARM720T, and ARM7EJ-S processors. The ARM7TDMI core is the industry's most widely used 32-bit embedded RISC microprocessor solution. Optimized for cost and power-sensitive applications, the ARM7TDMI solution provides the low power consumption, small size, and high performance needed in portable, embedded applications.

\*Corresponding author **Raghu Teja; N. Madhu** is working as Assistant Professor and **Polaiah Bojja** as Professor

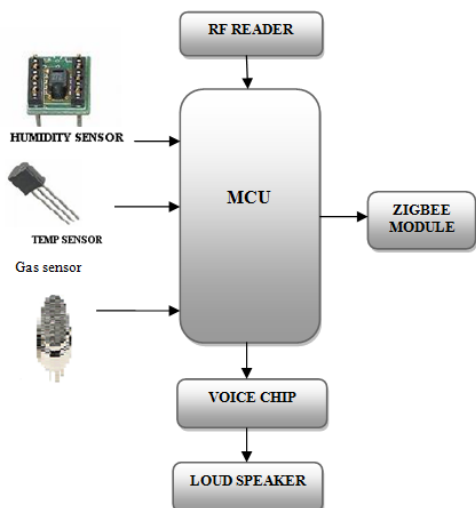

**Fig1:** Mine section

### ARM core

The ARM7 family includes the ARM7TDMI, ARM7TDMI-S, ARM720T, and ARM7EJ-S processors. The ARM7TDMI core is the industry's most widely used 32-bit embedded RISC microprocessor solution. Optimized for cost and power-sensitive applications, the ARM7TDMI solution provides the low power consumption, small size, and high performance needed in portable, embedded applications.

### LPC2148 Processor

LPC2148 Microcontroller Architecture. The ARM7TDMI-S is a general purpose 32-bit microprocessor, which offers high performance and very low power consumption. The ARM architecture is based on Reduced Instruction Set Computer (RISC) principles, and the instruction set and related decode mechanism are much simpler than those of micro programmed Complex Instruction Set Computers (CISC). This simplicity results in a high instruction throughput and impressive real-time interrupt response from a small and cost-effective processor core. Pipeline techniques are employed so that all parts of the processing and memory systems can operate continuously. Typically, while one instruction is being executed, its successor is being decoded, and a third instruction is being fetched from memory. The ARM7TDMI-S processor also employs a unique architectural strategy known as Thumb, which makes it ideally suited to high-volume applications with memory restrictions, or applications where code density is an issue.

### Temperature sensor

The LM35 pin diagram is shown in the figure 2. As a temperature sensor, the circuit will read the temperature of the surrounding environment and relay temperature to us back in degrees Celsius. The LM35 is

a low voltage IC which uses approximately +5VDC of power. This is ideal because the arduino's power pin gives out 5V of power.

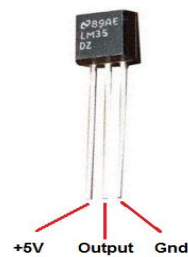
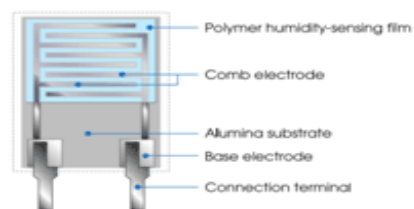

**Fig2.** Temperature sensor LM35

The IC has just three pins, two for the power supply and one for the analog output. The output pin provides an analog voltage output that is linearly proportional to the Celsius (centigrade) temperature. Pin two gives an output of one millivolt per 0.1°C (10mV per degree). So to get the degree value in Celsius, all that must be done is to take the voltage output and divide it by ten- this give out the value degrees in Celsius.

### Humidity sensor

Humidity is the presence of water in air. The amount of water vapour in air can affect human comfort as well as many manufacturing processes in industries. The presence of water vapour also influences various physical, chemical, and biological processes. Humidity measurement in industries is critical because it may affect the business cost of the product and the health and safety of the personnel. Hence, humidity sensing is very important, especially in the control systems for industrial processes and human comfort. Here we are using a resistive type of humidity sensor.



**Fig3.** Humidity sensor

### Gas sensor

A gas sensor is a device that detects the presence of gases in an area, often as part of a safety system. This type of equipment is used to detect a gas leak and interface with a control system. Gas sensor can detect combustible, flammable and toxic gases and oxygen depletion. A gas sensor can sound an alarm to operators in the area where the leak is occurring, giving them the opportunity to leave. This type of device is important because there are many gases that can be harmful to organic life, such as humans or animals.

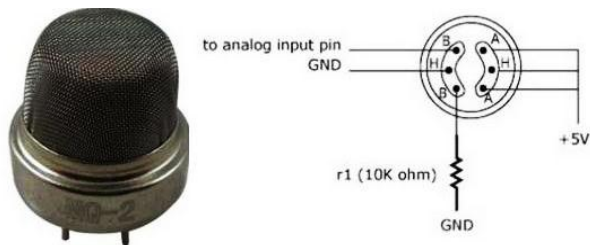

**Fig4:** Gas sensor

#### Voice chip

This is a new and enhanced 8 channel recordable voice module. Each channel can hold up to 1 minute of recorded voice and/or music with a combined total record time of eight minutes. In case of any threshold level exceeding of sensor, parameter exceeds voice will be played by the voice chip based on GPIO programming

#### RFID reader

A radio frequency identification reader (RFID reader) is a device used to gather information from an RFID tag, which is used to track individual Labours entering into the mine. In an RD reader, the Radio waves are used to transfer data from tag to reader. The RFID tag it must be within the range of an RFID reader, which ranges from 3 to 300 feet, in order to be read. RFID technology allows several items to be quickly scanned and enables fast identification of a particular product, even when it is surrounded by several other items. RFID technology uses digital data in an RFID tag, which is made up of integrated circuits containing a tiny antenna for transferring information to an RFID transceiver. The majority of RFID tags contain at least an integrated circuit for modulating and demodulating radio frequency and an antenna for transmitting and receiving signals. Frequency ranges vary from low frequencies of 125 to 134 kHz and 140 to 148.5 kHz, and high frequencies of 850 to 950 MHz and 2.4 to 2.5 GHz.

#### GSM Overview

A GSM modem is a wireless modem that works with a GSM wireless network.



**Fig.5:** GSM Module

communication. GSM is the name of a standardization group established in 1982 to create a common European mobile telephone standard that would formulate specifications for a pan-European mobile cellular radio system operating at 900 MHz. GSM modems support an extended set of AT commands. These extended AT commands are defined in the GSM standards.

#### Zigbee module

ZigBee is a specification for a high level protocol stack using small, low-power and low-cost radios. It based on IEEE 802.15.4 standard for Personal Area Network. ZigBee standard maintained by ZigBee Alliance. Usually vendors of ZigBee devices use system-on-chip (SoC) solutions with integrated radio and 60-250KB of flash memory. ZigBee data transmission rate varies from 20 to 900kbps. Its low power consumption limits transmission distances to 10-100 meters line of sight. ZigBee devices can transmit data over long distances by passing data through a mesh network of intermediate devices to reach more distant ones.

#### VB Platform

In this system we are using a monitoring section to display whether the labours ID card have been read or not and to check the sensor parameters.. This output will be displayed on the monitoring screen using visual basic software. The communication is made between the ground level mine section and the monitoring unit is made through zigbee protocol.

### 3. Design and Implementation

In this project mine environment monitoring system Based on wireless sensor networks (WSNs) using ZigBee is designed. In order to give proper security to mine, we are giving an ID card to the miners.

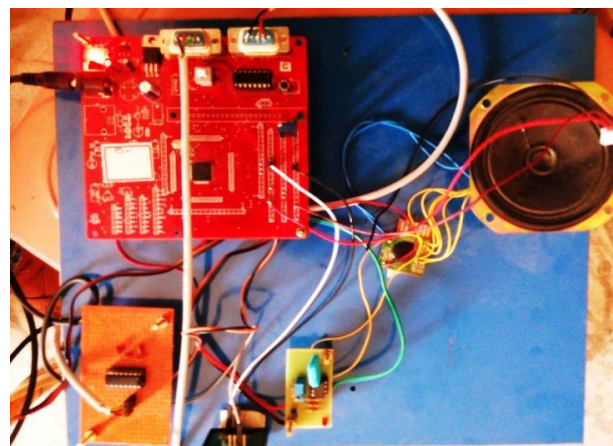

**Fig.6:** Hard ware of Mine section project

Global system for mobile communication (GSM) is a globally accepted standard for digital cellular

An RFID reader's function is to interrogate RFID tags. The means of interrogation is wireless and because the

distance is relatively short; line of sight between the reader and tags is not necessary. A reader contains an RF module, which acts as both a transmitter and receiver of radio frequency signals. The transmitter consists of an oscillator to create the carrier frequency; a modulator to impinge data commands upon this carrier signal and an amplifier to boost the signal enough to awaken the tag. The receiver has a demodulator to extract the returned data and also contains an amplifier to strengthen the signal for processing. ARM lpc2148, the control unit, which employs an operating system and memory to filter and store the data.

The data is now ready to be sent to the network through IEEE standard protocol. For monitoring purpose VB platform is introduced in this project work. Temperature sensor is used to monitor the temperature of the mine. Temperature sensor is connected to the lpc2148 processors ADC on chip peripheral. The ADC peripheral will be configured through program. The digital value of temperature sensor will be compared with the threshold value set in the program.

Resistive type humidity sensors pick up changes in the resistance value of the sensor element in response to the change in the humidity. Thick film conductor of precious metals like gold, ruthenium oxide is printed and calcinated in the shape of the comb to form an electrode. Then a polymeric film is applied on the electrode; the film acts as a humidity sensing film due to the existence of movable ions. Change in impedance occurs due to the change in the number of movable ions. This change in movable ions causes change in the resistive metal which in turn creates voltage change in the sensor. This will be a very minute voltage change. This voltage will be send to the ADC channel for the transmission. And also GAS sensor is connected to the lpc2148 it will sense the carbon monoxide and it will send ppm level to the ADC channel for the transmission. If any one or all the sensor values are exceeds the reference value then the program sets the voice alert. The sensor detail and the labour detail will be updated in the control room through the IEEE standard protocol. Any person can operate this from the control room. Always the in time and out time of a labour will be updated in the PC. And GSM is also connected to PC to send the message to fire and hospital departments.

In the flow chart we can easily analyze the project. It is the flow chart which explains the coal mine project. Firstly when we have to start the kit and then it will initialize the processor. Then the sensors which are in the kit will sense the values of temperature and humidity. And also the RFID reader which is in the kit it reads the ID cards of workers. If RFID cards accessed then it will continue and update worker details in the VB monitoring software. And the values of sensors are exceeds the threshold values then it will give the voice alert and update on VB monitoring software and it follows the step of sending SMS to the fire and hospital departments. If the values of sensors are not exceed the threshold values it will go back and again sense the values and update in the VB monitoring display. So it is the continuous process.

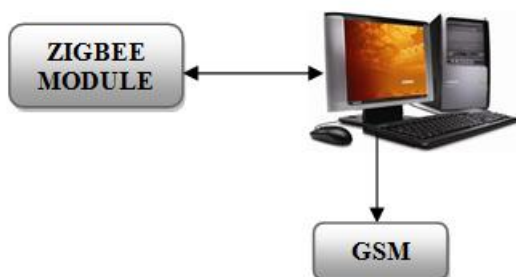
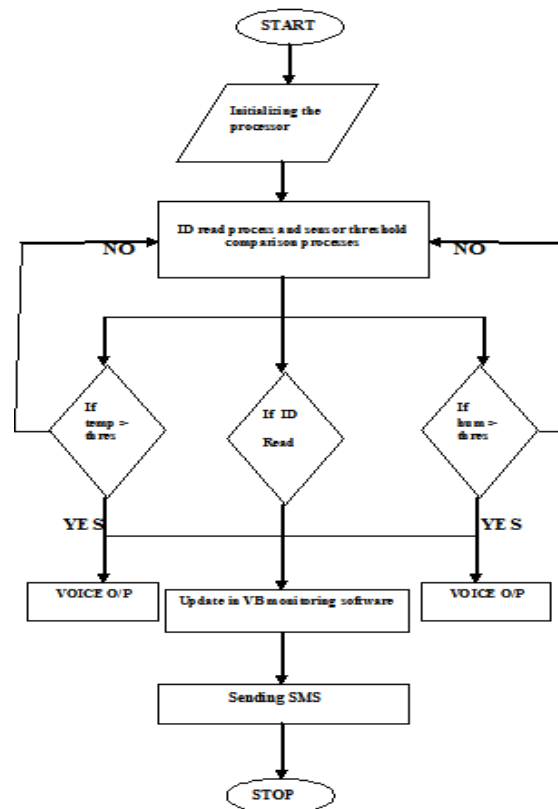

Fig.7: Flow chart of Coal Mine project



Fig.8: Values of sensor and in time and out time of person RFID card 1



**Fig.9:** Values of sensor and in time and out time of person RFID card 2

## Conclusion

In this project we proposed a mine monitoring system using wireless. Which in turn replace the cable connection between the mine and control room. Wireless sensor networks (WSNs) using ZigBee is designed to transmit the sensor data to the monitor.. Sensor nodes are responsible for the collection of environmental parameters, and sending the collected data. Sensor nodes were arranged under tungsten mine flexibly. In order to give proper security to mine, we are giving an ID card to the miners. All these facilities improve mine safety effectively.

## References

- Safaric S., Malaric K. (June 2006), ZigBee wireless standard, Multimedia Signal Processing and Communications, 48<sup>th</sup> International Symposium ELMAR-2006, Zadar, Croatia.
- Sana Saadaoui and Lars Wolf (2007), Architecture Concept of a Wireless Body Area Sensor Network for Health Monitoring of Elderly People, Vol.1, No.3.

- L. B. Becker and C. E. Pereira (Aug. 2001), SIMOO-RT—An object-oriented framework for the development of real-time industrial automation systems, *IEEE Trans. Robot.*, vol. 18, no. 4, pp. 421–430
- R. Brennan, M. Fletcher, and D. Norrie (Aug. 2001), An agent-based approach to reconfiguration of real-time distributed control systems, *IEEE Trans. Robot. Autom.*, vol. 18, no. 4, pp. 444–451
- I. A. D. Nesnas, A. Wright, M. Bajracharya, R. Simmons, and T. Estlin (2003), CLARATy and challenges of developing interoperable robotic software, in *Proc. 2003 IEEE/RSJ Int. Conf. Intell. Robot. Syst.*, pp. 2428–243
- Y. Hsin Kuo and B. MacDonald (2005), A distributed real-time software framework for robotic applications, in *Proc. IEEE Int. Conf. Robot. Autom.*, pp. 1964–1969.



Mr. M. Raghu Teja is working towards a Master of Technology in E.C.E in Embedded systems at prestigious Vardhaman College of Engineering, Hyderabad. He has completed B.Tech from Samskruti Engineering college, R.R. Dist, Hyderabad.



Mr. N. Madhu is presently working as Assistant professor of Electronics Comm. Engineering in prestigious Vardhaman College of Engineering Hyderabad, India. He obtained B.Tech from Sphoorthy Engineering College. M.Tech from Vardhaman Engineering College.



Mr. Polaiah Bojja is presently working as Professor of Electronics Comm. Engineering in prestigious Sree Vidyanikethan Engg. College, Tirupati, India. He obtained B.Tech from Sree vidyanikethan engineering college, Hyderabad. M.Tech from Annamalai university, Tamilnadu. Ph.d from JNTU Ananthapur. Andhra Pradesh.