

14th CIRP Conference on Computer Aided Tolerancing (CAT)

Virtual metrology laboratory for e-learning

A. Ballu^{a*}, X. Yan^a, A. Blanchard^b, T. Clet^b, S. Mouton^c, H. Niandou^a

^aUniv. Bordeaux, I2M, UMR 5295, 33400 Talence, France

^bUniv. Bordeaux, Mission Investissements d'avenir, 33000 Bordeaux, France

^cUniv. Bordeaux, Collège Sciences et Technologies, 33400 Talence, France

* Corresponding author. Tel.: +33 5 4000 66 13; fax: +33 5 4000 69 64. E-mail address: alex.ballu@u-bordeaux.fr

Abstract

Understanding geometrical specifications is becoming more and more difficult due to the latest developments in ISO GPS (Geometrical Product Specification) Standards, and at the same time, students' learning habits are evolving and theoretical courses on standardized specifications are not attractive. Metrology laboratory work is much more appealing and highlights the difficulties encountered in interpreting specifications and the inherent method uncertainties. Nevertheless, metrology activities require an expensive metrology laboratory equipped with CMMs. In order to carry out real hands-on experiments, Bordeaux University is designing a virtual laboratory framework. It is integrated into Moodle (an L.M.S., Learning Management System) as a new activity to establish a link with other Moodle learning activities (courses, tests, etc.) and to ensure student tracking. A first prototype of the virtual laboratory is dedicated to dimensional and geometrical metrology with simulated traditional measuring devices (gauge, micrometer, dial indicator, etc.) and Coordinate Measuring Machines. Measurement simulation is in a three-dimensional environment and is based on models of parts with dimensions, orientation, position and form errors (skin model shapes) and on models of measuring devices with measurement uncertainties.

© 2016 The Authors. Published by Elsevier B.V. This is an open access article under the CC BY-NC-ND license (<http://creativecommons.org/licenses/by-nc-nd/4.0/>).

Peer-review under responsibility of the organizing committee of the 14th CIRP Conference on Computer Aided Tolerancing

Keywords: ISO GPS; e-learning; virtual laboratory; hands-on laboratory; skin model shape

1. Introduction

1.1. Concerns

Classroom lessons at the University are not always fully appreciated by the students. In traditional forms of learning, through physical attendance, both student learning and teacher motivation may be affected by external stimuli, or simply by lack of attentiveness and interest.

Furthermore, scientific and technological studies are based on the practical application of theoretical learning, through the manipulation of objects and instruments. Practical classes planned for this purpose require a dedicated time slot and an appropriate room. The large numbers of students registered in the first years of higher education, material limitations (number of rooms, facilities) and a lack of human resources make it difficult to learn only by practical exercises in classroom.

Given the evolution of students' attention span, the lack of time and resources for the acquisition of knowledge through practice, one solution is to develop an educational strategy based on a Learning Management System (LMS) integrating a Virtual Laboratory (VL).

Using virtual lab sessions, following different scenarios, teaching classes (lessons or practical exercises) can be prepared remotely to consolidate classroom learning and acquire additional knowledge.

1.2. Existing online laboratories

Online laboratories have been developed for a couple of years now. From a technological point of view, one can distinguish remote laboratories and virtual laboratories.

1.2.1. Remote laboratories

The aim of remote laboratories is to conduct real experiments through internet communication from home or

anyplace. Remote laboratories are very well adapted to experiments with reduced handling, essentially electronics experiments [1]. The measures on an electrical circuit require just a short time of use of the remote laboratory, and many students can follow one another in rapid succession. Bending a beam [2] is another example of quick measurement in mechanics. Other areas of application for remote laboratories are optics [3] or robotics. Remote laboratories can also be used for expensive experiments or dangerous manipulations. Experiments must fulfil two requirements for remote and wide access: they should be automated and short. This is not the case for dimensional metrology.

1.2.2. Virtual laboratories

Virtual laboratories (VL) are another way to develop online laboratories. Simulation software has long been used for teaching. The real integration of virtual laboratories, with a 3D environment, is more recent.

Some examples are presented here. In [4] a winder for textile engineering is simulated using Virtools, [5] reproduces microscopy imaging of material. An online laboratory for biotechnology is presented in [6] and comprises several different scenarios. A laboratory for process control experiments has been developed with three access modes (hands-on, virtual and remote) [7]. To find a review on virtual laboratories in science has been edited [8].

Nevertheless, the use of information technology for education leads mostly to formatted activities. The interactions between the student and the learning medium are reduced to predefined scenarios, which are few in number.

1.3. Project and objectives

This paper presents a virtual laboratory platform developed at the University of Bordeaux. This project is in a definition and experimental phase and is not yet complete. The target audience is students in bachelor's and master's science and technology degrees with most of the students concerned being on bachelor's degree programs. The virtual laboratory should enhance the offer of online educational materials and help and motivate the younger students in their discovery of science and technology at the university.

In a second phase, the platform is intended to be open to high schools and lifelong learning. If the project is to be sustainable, it requires extensive use of the platform by users and ownership by teachers. The founding principles of the platform are presented below.

1.3.1. 3D environment

Considering the extensive use of CAD-CAM-CAE systems by the students, the 3D games they play, the progress of virtual reality, the 3D problems encountered in dimensional and geometrical metrology, the project is firmly committed to 3D, even if, from a pedagogical point of view, 2D is often sufficient. Nevertheless, a 2D environment is still considered for some exercises, to simplify the user interface.

3D Virtual Lab content is the same as real lab content. A set of observation and measurement instruments must be available as well as "bodies" (mechanical parts, optical

components, electronic components, chemical equipment, etc.) and "substances" (materials, acids, reactives, etc.). The student will interact in 3D with these objects and substances through actions: moving, lifting, opening, closing, pouring, etc.

1.3.2. Open experimental procedure

Virtual experiments will leave a degree of initiative to the student, who must have some freedom of action. The manipulations should not be imposed. Depending on his scientific and technical skill, the student must conduct experimental procedures as he wishes, with the tools and objects provided by the teacher. He should not be restricted to a linear storyline, predefined and formatted.

The teacher, for his part, creates a virtual experiment exercise proposing targets and educational scenarios on Moodle, and prepares the virtual 3D environment, selecting the tools (instruments for measuring, observing, handling, etc.), and the objects (solid, liquid, gas, that can be measured, observed, manipulated) available in the student interface.

1.3.3. Disciplinary openness

The virtual lab aims to host all kinds of experimental work, in different areas of physics (mechanics, electronics, optics, etc.) but also in other sectors such as chemistry, and perhaps biology.

Using a modular design from the beginning of the project should make it easy to add items, tools, behaviors, etc., while keeping the same platform (user interface, connection to the LMS, student session management, etc.). Obviously, for each discipline specific modules will need to be developed.

1.3.4. Consideration of uncertainties

In most of the existing VLs [4-7], the variability of parameters and measurement of uncertainties are not usually considered. Yet this plays a key part in the analysis of the experimental results provided by practical exercises.

One of the main pedagogical innovations of the project is based on considering the variability of the input parameters and uncertainties of the measuring instruments.

1.3.5. Integration into an LMS

This new "virtual laboratory" is to be integrated into an LMS (Learning Management System), Moodle initially, and can be interfaced with existing educational tools.

The LMS tools are used to build training courses including a virtual laboratory with an adequate sequencing of educational activities. The scenario of the virtual experiment is not part of the virtual laboratory, it is defined in Moodle. The virtual laboratory is seen as a simulation tool.

The virtual experiment should become an LMS activity in itself, like any other educational activity, but using a 3D environment.

1.3.6. WEB application

As it is to be used by every student, everywhere, independently of the operating system used (Windows, iOS, Android, etc.), the choice of application structure fell on a web application.

If possible, the application should not require the installation of a plug-in to the browser with a solution based on WebGL and Javascript. However, this is not imperative and Unity 3D or equivalent game engines are not excluded.

1.4. Main contributions

One criteria enounced to characterize a virtual laboratory in [8] is not retained; it concerns the principle of share space in a virtual world between students and teachers.

The reason for developing another new virtual laboratory is that these founding principles are not encountered altogether in a VL. Among these principles, it is very rare to have open experimental procedure, different disciplines and consideration of uncertainties. The objective of the project is to meet these requirements.

2. The virtual laboratory

2.1. Student interface

To have a better idea of the concepts of a virtual laboratory, one of the first student graphical interfaces is presented in figure 1, this is a preliminary interface and will develop as the project progresses.

2.1.1. Work area

The main area, or work area, is the "virtual laboratory" itself, a 3D space into which students drop various virtual objects and make them interact. The 3D environment helps to manage the effects of gravity, collisions, flow of liquids, etc. This is the place where the student will execute the various activities necessary for experimentation.

2.1.2. Library

The Library is a set of tabs from which the student can select and drag and drop the virtual objects to the work area. The object visuals may be 2D for simplicity purposes. As a reminder, the virtual objects are:

- bodies: mechanical part to be measured, bending beam, lens, mirror, prism, magnet, power, resistance, transistor, integrated circuits, beaker, pipette, heater, etc.
- substances: aluminum powder, nitric acid, sulfuric acid, sodium hydroxide, glucose, etc.
- observation and measuring instruments: caliper, indicator, CMM, strain gauge, multimeter, oscilloscope, chronometer, scale, hygrometer, microscope, pH meter, etc.

Some objects are parameterized: resistance, heating temperature, oscilloscope settings, etc. These parameters can be modified as the objects are dropped into the 3D scene or during handling.

2.1.3. Experimental procedure

The platform should be able to record the completed actions, i.e. the experimental procedure in place. The list of actions is displayed in the experimental procedure area to the right of the interface.

The first objective is to "trace" the experimental approach so that the student can modify it later to correct his mistakes,

improve the procedure or make comparisons between variants. The second objective is to be able to "replay" an experimental procedure. This is essential because it enables the student to repeat the current experiment several times, taking into account any uncertainties related to the experiment (measurement uncertainties, or implementation uncertainties). Measurement results differ according to the introduced uncertainties and statistical analyses are carried out by the students to analyze these uncertainties.

2.1.4. Data area

The data area is the dashboard of the laboratory. In this interface, input and output variables are displayed. The input variables are parameters related to objects used. The output variables are responses from the measuring instruments dropped into the work area.

2.2. Simulation

A key feature of the laboratory is the definition and integration of the behavior of the virtual objects and their mutual interactions. Two aspects of the simulation are distinguished:

- 3D simulation for viewing objects in the work area,
- simulation to compute the responses from virtual instruments displayed in the data area.

The first requires a response in real time without the need for high precision. It is sufficient that the result is acceptable from a visual point of view. To this end, an ordinary physics engine developed for virtual environments, 3D games or serious games is an ideal solution.

The simulation for measurements requires a high level of precision but the calculation time can be longer (few seconds) because this simulation is only triggered during the action of measuring. In this case, specific modules are developed, which need to model the phenomena involved and the measurement uncertainties in detail. These modules are specific to a discipline (dimensional metrology, structural mechanics, etc.).

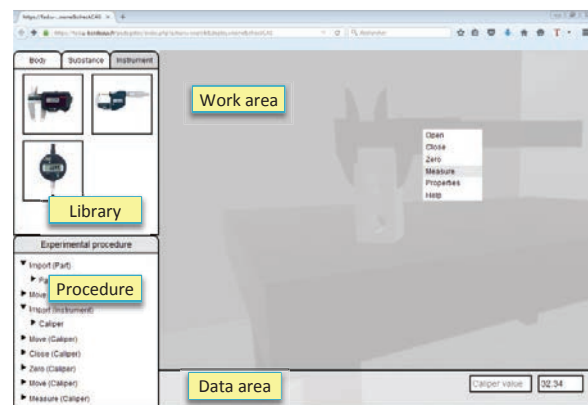

Fig. 1. Student graphical interface in the virtual laboratory.

3. Virtual metrology

A first prototype is under development. It concerns dimensional metrology. Several interactive applications exist for dimensional metrology [9] and calibration [10], but they are not really virtual laboratories. Three simulations are under development with three different measuring devices: caliper, micrometer and indicator.

3.1. Objects

The objects are:

- the measuring instruments: caliper, micrometer, indicator,
- their accessories: gauge blocks, indicator support, granite surface plate,
- the parts to be measured.

For each object, a 3D model is created and the parameters and actions are identified. The parameters of the caliper are

Table 1. Caliper parameters and actions.



Caliper	
Teacher's parameters	<ul style="list-style-type: none"> • Range of measurement (maximum distance) • Resolution • Null measurement uncertainty (standard deviation) • Measurement uncertainty (standard deviation)
Actions	<ul style="list-style-type: none"> • Move, Drop • Disable gravity on the caliper (to facilitate the measuring operation, it remains in the air so that it can be positioned easily on the part). • Open the caliper, stop opening at the maximum distance • Close the caliper Stop closing when the jaws are in contact or when an object blocks the jaws. During closing, orientation of the caliper normal to the surfaces in contact. • Zeroing (when the caliper is closed) • Read off the measured value.

Table 2. Gauge block parameters and actions.

Gauge blocks	
Teacher's parameters	<ul style="list-style-type: none"> • List of the gauge block lengths • Length uncertainty (standard deviation) • Block stacking uncertainty (average + standard deviation)
Student's parameters	<ul style="list-style-type: none"> • List of stacked blocks
Actions	<ul style="list-style-type: none"> • Take a particular block or a block stack from the box. • Move, Drop • Put a block or a block stack in the box.

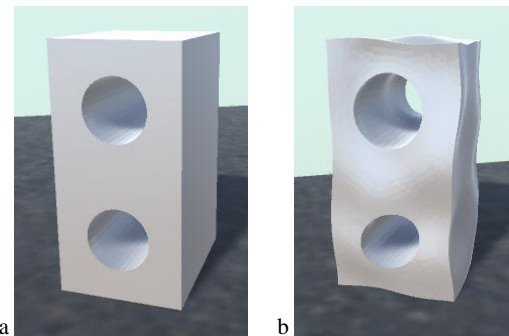

Fig. 2. (a) Nominal part, (b) skin model shape.

given in table 1, and the parameters of the Gauge blocks in table 2. Depending on the type of parameters, their values are given by the teacher during preparation for the virtual experiment, or by the student during the session.

The parts have no parameters and the actions are reduced to move and drop. In order to handle the part in 3D, a nominal model is created. However, to take into account the effect of form defect on the measurement, a skin model shape is also created from the nominal model [11-15]. A skin model shape is a surface mesh representing the part with form defects. Each vertex of the mesh has a deviation normal to the surface. Figure 2b presents a particular, non-realistic, skin model shape with deviations magnified so that they are visible. If the deviations are not magnified, the difference cannot be perceived with the naked eye.

3.2. Virtual measurement with caliper

Figure 3 presents a prototype view of the virtual laboratory produced with Unity 3D. A nominal part is measured with a caliper. As described above, measurement is not computed from the 3D scene but from the skin model shape.

Based on the 3D scene, the relative location of the caliper with respect to the part is recorded. On the skin model shape, two thin rectangular planes are fitted to the mesh in the recorded location. The planes are constrained to be parallel and outside the material. The objective function is to minimize the distance between the planes, which simulate the caliper jaws. The displayed value is equal to the plane-plane distance



Fig. 3. Measurement with caliper.

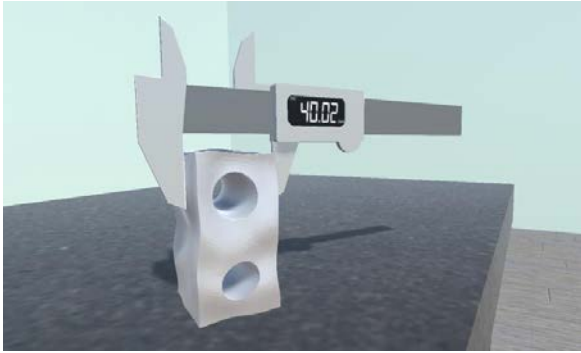

Fig. 4. Measurement of magnified skin model shape with caliper.

plus random values representing the caliper measurement uncertainties. As a first step, the probability distributions of the random value will be normal and identified by standard deviations (see table 1: null measurement uncertainty and measurement uncertainty).

Instead of using a nominal part, the magnified skin model may be introduced into the scene (Figure 4). The aim is to point out the role of form defect on the distance measured with the caliper. In the figure, one can observe point contact, instead of surface contact, between the caliper and the surface. The simulation shows the phenomena involved in dimensional metrology.

3.3. Virtual measurement with indicator and gauge blocks

In figure 5, a different part is measured with a digital indicator and gauge blocks. In this case, the deviations are magnified. As previously, the relative location of the caliper with respect to the part is recorded from the 3D scene.

Part-plate contact is simulated by fitting a plane to the part. The plane is constrained to be outside the material. The objective function is related to gravity: the distance between the barycenter of the part and the plane is minimized. According to the recorded location of the indicator, the contacting point is determined, as well as the distance from this point to the plane.

Previously, the indicator on the gauge block was adjusted to zero. The value displayed by the indicator is finally equal to the difference between the distance to the plane and the gauge height.

Random values representing uncertainties of the indicator and of the gauge are added.

4. Future developments for metrology

The objective for unidimensional metrology is to add further objects to offer a complete laboratory for dimensional metrology:

- measuring devices: depth and internal micrometers, height gauge, etc.,
- auxiliary equipment: V-block, square, sine plate, bench center, metrology fixtures, etc.

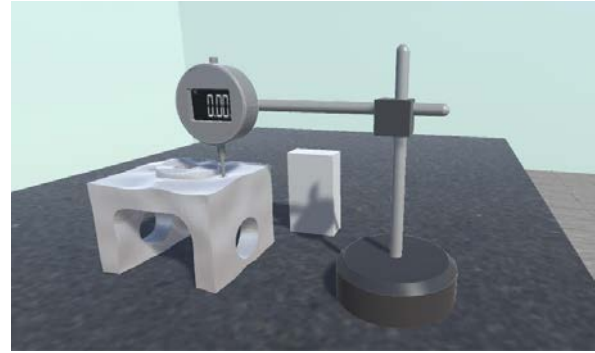

Fig. 5. Measurement of magnified skin model shape with digital indicator.

In the future, the idea is to go beyond unidimensional metrology, and move towards 3D coordinate metrology and verification of complex geometrical specifications.

4.1. Coordinate measuring device

First, coordinate measuring devices must be put in the 3D scene. Two main physical principles are used for coordinate measurement: mechanical and optical. The two technologies are interesting for educational purposes.

For mechanical technology, the concepts to highlight are: measuring point, machine and part coordinate systems, probe calibration, choice of stylus, orientation of the part, choice of measuring points, etc.

For optical technology, the concepts are: target position, 3D mesh alignment, mesh and CAD model alignment, feature visibility, etc.

4.2. Verification

Once measuring points are recorded, the point coordinates are used to inspect standardized specifications (figure 6). Numerous points have to be addressed with the students: GD&T, association criteria, alignment and datum, constructed features, etc.

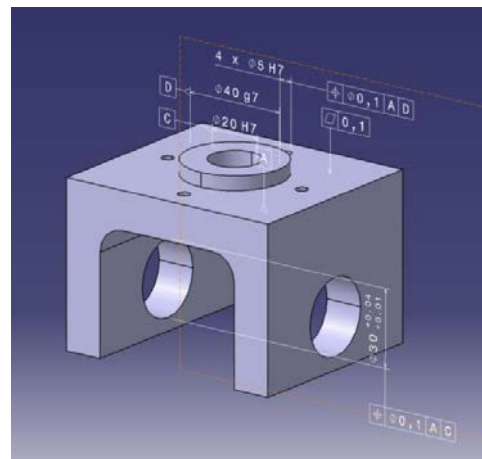

Fig. 6. Geometrical specifications (Catia FTA).

If the educational aim is to improve the students' GD&T skills, the complete skin model shape may be used. The treatment of the points to verify GD&T specifications is then applied directly to the mesh of the skin model shape, without using virtual measuring devices. This makes it possible to partition, associate and construct ideal features on the skin model shape to represent tolerance features, datum features and tolerance zones. Figure 7 shows the features used to verify the location of the hole $\phi 30$ in figure 6: datum plane and datum axis, median lines and axis of a cylindrical tolerance zone.

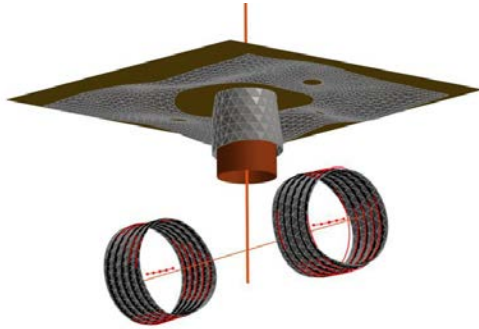

Fig. 7. Virtual metrology on skin model shape.

4.3. Benefit for GPS teaching

The proposed virtual laboratory may be complementary to European projects on GPS (Geometrical Product Specification) teaching [16][17]. In contrast to the predefined scenarios created in Virtools by Dassault Systemes [18] or in Adobe Flash by Humienny [19], the student will construct and define the standardized specification by himself. He will experiment verification with different measuring instruments.

The project under development will ensure an active approach to GPS learning.

5. Conclusion and future work

An ambitious project has been launched by Bordeaux University on virtual laboratories for physics or sciences in general and their technological applications. The project is based on 3D simulation in a web application to allow the laboratory to be widely used. The platform integrates a communication module with an LMS (Moodle) to manage the accounts and personal data, and to provide support for the experimental exercises.

The first prototype application is under development for dimensional metrology classes. The next step will be to extend the prototype to geometrical metrology. By implementing the guiding principles, it is expected that the application can be extended to other disciplines with the same platform.

Evaluation is not addressed in this paper because of the difficulty of evaluating work when different solutions may be proposed for the same goal. One way of carrying out evaluation, or validation to be more precise, would be to compare the student's result to a reference value.

Acknowledgements

This work was carried out with financial support from the French State, managed by the French National Research Agency (ANR) in the framework of the "Investments for the future" Program IdEx Bordeaux (ANR-10-IDEX-03-02).

The authors would like to thank the China Scholarship Council (CSC) for research funding.

References

- [1] Alamo J. A., Chang V., Hardison J., Zych D., Hui L. An Online Microelectronics Device Characterization Laboratory with a Circuit-like User Interface. International Conference on Engineering Education. July 21-25 2003, Valencia, Spain
- [2] Restivo M. T., Mendes J., Lopes A. M., Silva C. M., and Chouzal F. A Remote Laboratory in Engineering Measurement. IEEE Transactions on industrial electronics, 2009, 56(12):4836-4843
- [3] Osten W., Wilke M., Pedrini G. Remote laboratories for optical metrology: from the lab to the cloud. Optical Engineering, 2013, 52(10): 101914,1-10.
- [4] Liu J., Jiang H. Development of a Virtual Winder for Computer-Aided Education Using Virtools. Computer Applications in Engineering Education. 2014; 22(1):120-130.
- [5] Dobrzański L.A., Honysz R. Development of the virtual light microscope for a material science virtual laboratory. Journal of Achievements in Materials and Manufacturing Engineering. 2007;20(1-2):571-574
- [6] Bonde, M., Makransky, G., Wandall, J., Larsen, M. V., Morsing, M., Jarmer, H. Ø., & Sommer, M. Improving biotech education through gamified laboratory simulations. Nature Biotechnology, 2014;32(7), 694-697.
- [7] Abdulwahed M. Nagy Z. K. Developing the TriLab, a Triple Access Mode (Hands-On, Virtual, Remote) Laboratory, of a Process Control Rig Using LabVIEW and Joomla. Computer Applications in Engineering Education. 2013;21(4):614-626.
- [8] Potkonjak V., Gardner M., Callaghan V., Mattila P., Guetl C., Petrović V.M., Jovanović K., Virtual laboratories in science, and engineering: a review, Computers & Education, 2016.
- [9] Al-Zahrani F. Web-Based Learning and Training for Virtual Metrology Lab. Journal of Telecommunications, 2010;1(2):42-54.
- [10] Gomez E., Caja J., Maresca P., Barajas C., Berzal M. Interactive Dimensional Calibration Via Internet. Computer Applications in Engineering Education. 2013;21(3):387-399.
- [11] Zhang, M., Anwer, N., Stockinger, A., Mathieu, L., Wartzack, S. Discrete shape modeling for skin model representation. Proceedings of the Institution of Mechanical Engineers, Part B: Journal of Engineering Manufacture 2013;227(5):672-680.
- [12] Zhang, M., Shi, Z., Mathieu, L., Nabil, A., Yang, J. Geometric product specification of gears: The geospeiling perspective. Procedia CIRP, 2015;27:90-96.
- [13] Schleich, B., Anwer, N., Mathieu, L., Wartzack, S. Skin model shapes: Offering new potentials for modelling product shape variability. ASME IDETC/CIE 2015, Boston, USA 2015;.
- [14] Franciosa, P., Gerbino, S., Patalano, S. Simulation of variational compliant assemblies with shape errors based on morphing mesh approach. The International Journal of Advanced Manufacturing Technology 2011;53(1-4):47-61.
- [15] Wagersten, O., Lindau, B., Lindkvist, L., Söderberg, R. Using morphing techniques in early variation analysis. Journal of Computing and Information Science in Engineering 2014;14(1):011007.
- [16] Geometrical Product Specification Course for Technical Universities, European Commission project Leonardo da Vinci Programme, 1999-2001
- [17] Geometrical Product Specification and Verification Toolbox, European Commission project Erasmus+ Programme, 2015-2018
- [18] 3D tolerancing based on ASME Y14.41-2003, Dassault Systemes
- [19] Humienny Z.; Berta M.: Using Animations to Support the Understanding of Geometrical Tolerancing Concepts. 11th International Symposium on Measurement and Quality Control 2013, September 11-13, 2013, Electronic Proceedings, Cracow-Kielce, Poland.