



ارائه شده توسط:

سایت ترجمه فا

مرجع جدیدترین مقالات ترجمه شده

از نشریات معتبر

Coordinated Design of TCSC Controller and PSS Employing Particle Swarm Optimization Technique

Sidhartha Panda, and N. P. Padhy

Abstract—This paper investigates the application of Particle Swarm Optimization (PSO) technique for coordinated design of a Power System Stabilizer (PSS) and a Thyristor Controlled Series Compensator (TCSC)-based controller to enhance the power system stability. The design problem of PSS and TCSC-based controllers is formulated as a time domain based optimization problem. PSO algorithm is employed to search for optimal controller parameters. By minimizing the time-domain based objective function, in which the deviation in the oscillatory rotor speed of the generator is involved; stability performance of the system is improved. To compare the capability of PSS and TCSC-based controller, both are designed independently first and then in a coordinated manner for individual and coordinated application. The proposed controllers are tested on a weakly connected power system. The eigenvalue analysis and non-linear simulation results are presented to show the effectiveness of the coordinated design approach over individual design. The simulation results show that the proposed controllers are effective in damping low frequency oscillations resulting from various small disturbances like change in mechanical power input and reference voltage setting.

Keywords—Particle swarm optimization, Phillips-Heffron model, power system stability, PSS, TCSC.

I. INTRODUCTION

LOW frequency oscillations are observed when large power systems are interconnected by relatively weak tie lines. These oscillations may sustain and grow to cause system separation if no adequate damping is available [1]. Power system stabilizers (PSS) are now routinely used in the industry to damp out oscillations. However, during some operating conditions, this device may not produce adequate damping, and other effective alternatives are needed in addition to PSS. Recent development of power electronics introduces the use of flexible ac transmission system (FACTS) controllers in power systems. FACTS controllers are capable of controlling the network condition in a very fast manner and this feature of FACTS can be exploited to improve the stability of a power system [2]. Thyristor Controlled Series Compensator (TCSC) is one of the important members of FACTS family that is increasingly applied with long transmission lines by the utilities in modern power systems. It can have various roles in

the operation and control of power systems, such as scheduling power flow; decreasing unsymmetrical components; reducing net loss; providing voltage support; limiting short-circuit currents; mitigating subsynchronous resonance (SSR); damping the power oscillation; and enhancing transient stability [3]-[6]. The problem of FACTS controller parameter tuning in the presence of PSS is a complex exercise as uncoordinated local control of FACTS controller and PSS may cause destabilizing interactions. To improve overall system performance, PSSs and FACTS Power Oscillation Damping (POD) controllers should operate in coordinated manner [7]-[8].

A conventional lead-lag controller structure is preferred by the power system utilities because of the ease of on-line tuning and also lack of assurance of the stability by some adaptive or variable structure techniques. Traditionally, for the small signal stability studies of a power system, the linear model of Phillips-Heffron has been used for years, providing reliable results. Although the model is a linear model, it is quite accurate for studying low frequency oscillations and stability of power systems. It has also been successfully used for designing and tuning the classical PSSs [9]. The problem of FACTS controller parameter tuning is a complex exercise. A number of conventional techniques have been reported in the literature pertaining to design problems of conventional power system stabilizers namely: the eigenvalue assignment, mathematical programming, gradient procedure for optimization and also the modern control theory. Unfortunately, the conventional techniques are time consuming as they are iterative and require heavy computation burden and slow convergence. In addition, the search process is susceptible to be trapped in local minima and the solution obtained may not be optimal [10].

Recently, Particle Swarm Optimization (PSO) technique appeared as a promising algorithm for handling the optimization problems. PSO is a population based stochastic optimization technique, inspired by social behavior of bird flocking or fish schooling [11]. PSO shares many similarities with Genetic Algorithm (GA) optimization technique; like initialization of population of random solutions and search for the optimal by updating generations. However, unlike GA, PSO has no evolution operators such as crossover and mutation. One of the most promising advantages of PSO over GA is its algorithmic simplicity as it uses a few parameters and easy to implement. In PSO, the potential solutions, called

Sidhartha Panda is a research scholar in the Department of Electrical Engineering, Indian Institute of Technology, Roorkee, Uttaranchal, 247667, India (e-mail: speeddee@iitr.ernet.in, panda_sidhartha@rediffmail.com).

N. P. Padhy is Associate professor in the Department of Electrical Engineering, IIT, Roorkee India (e-mail: nppeefee@iitr.ernet.in).

particles, fly through the problem space by following the current optimum particles [12].

In this paper, a comprehensive assessment of the effects of the PSS and TCSC-based control when applied independently and also through coordinated application has been carried out. The design problem of PSS and TCSC-based controller to improve power system stability is transformed into an optimization problem. The design objective is to improve the stability of a single-machine-infinite-bus power system, subjected to a disturbance. PSO technique is employed to search for the optimal PSS and TCSC controller parameters. PSO-based TCSC stabilizer (PSOTCSC) and PSO-based PSS (PSOPSS) design are presented and their performance is compared with a conventional power system stabilizer (CPSS). Simulation results are presented to demonstrate the effectiveness of the proposed stabilizers to improve the power system dynamic stability.

II. MODELING THE POWER SYSTEM WITH TCSC AND PSS

The single-machine infinite-bus power system shown in Fig. 1 is considered in this study. The generator is equipped with a PSS and the system has a TCSC installed in transmission line. In the figure X_T and X_L represent the reactance of the transformer and the transmission line respectively, V_T and V_B are the generator terminal and infinite bus voltage respectively.

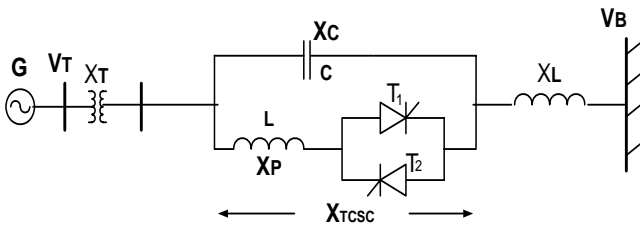

Fig. 1 Single machine infinite bus power system with TCSC

A. The Non-Linear Equations

The non-linear differential equations of the single machine infinite bus power system with TCSC are [1, 9]:

$$\dot{\delta} = \omega_b \Delta\omega \tag{1}$$

$$\dot{\omega} = \frac{1}{M} [P_m - P_e] \tag{2}$$

$$\dot{E}'_q = \frac{1}{T_{do}} [-E_q + E_{fd}] \tag{3}$$

$$\dot{E}'_{fd} = \frac{K_A}{1 + sT_A} [V_R - V_T + V_S] \tag{4}$$

where,

$$P_e = \frac{E'_q V_B}{X_{d\Sigma'}} \sin \delta - \frac{V_B^2 (X_q - X'_d)}{2X_{d\Sigma'} X_{q\Sigma'}} \sin 2\delta \tag{5}$$

$$E_q = \frac{X_{d\Sigma'} E'_q}{X_{d\Sigma'}} - \frac{(X_q - X'_d)}{X_{d\Sigma'}} V_B \cos \delta \tag{6}$$

$$V_{Td} = \frac{X_q V_B}{X_{q\Sigma'}} \sin \delta \tag{7}$$

$$V_{Tq} = \frac{X_{Eff} E'_q}{X_{d\Sigma'}} + \frac{V_B X'_d}{X_{d\Sigma'}} \cos \delta \tag{8}$$

$$V_T = \sqrt{(V_{Td}^2 + V_{Tq}^2)} \tag{9}$$

with,

$$X_{Eff} = X_T + X_L - X_{CF} - X_{TCSC}(\alpha)$$

$$X'_{d\Sigma'} = X'_d + X_{Eff}, X'_{q\Sigma'} = X_q + X_{Eff}$$

$$X_{d\Sigma} = X_d + X_{Eff}$$

The IEEE Type-ST1A excitation system is considered in this work. A widely used conventional lead-lag PSS is considered in this study. The diagram of the IEEE Type-ST1A excitation system and the PSS is shown in Fig. 2.

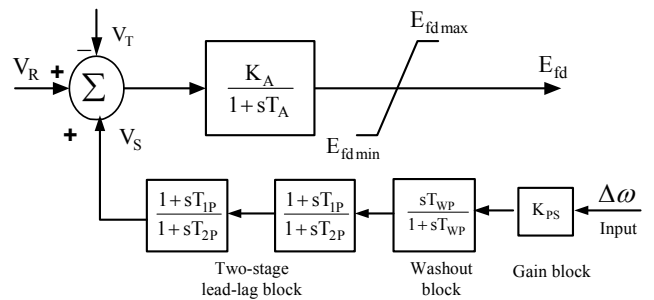

Fig. 2 IEEE Type ST1A excitation system with PSS

A simplified small perturbation model of excitation system is considered in the present study. The inputs to the excitation system are the terminal voltage V_T , reference voltage V_R and the signal from the PSS output V_S . K_A and T_A are the gain and time constant of the excitation system. The PSS considered in the present study consists of a gain block, a signal washout block and two-stage phase compensation block. In this structure, T_{WP} is the washout time constant and $T_{WP}=10$ sec is

used in the present study. The input to the PSS is the speed deviation $\Delta\omega$. Further two similar phase compensator blocks are considered so that $T_{1P} = T_{3P}$ and $T_{2P} = T_{4P}$. The stabilizer gain K_{PS} and time constants T_{1P} and T_{2P} are to be determined.

B. Linearized Model

In the design of electromechanical mode damping stabilizer, a linearized incremental model around an operating point is usually employed [1, 13]. The Phillips-Heffron model of the power system with FACTS devices is obtained by linearizing equations (1) – (4) around an operating condition of the power system. The linearized expressions are as follows:

$$\dot{\Delta\delta} = \omega_b \Delta\omega \tag{10}$$

$$\dot{\Delta\omega} = [-K_1 \Delta\delta - K_2 \Delta E'_q - K_P \Delta\sigma - D \Delta\omega] / M \tag{11}$$

$$\dot{\Delta E'_q} = [-K_3 \Delta E'_q - K_4 \Delta\delta - K_Q \Delta\sigma + \Delta E_{fd}] / T_{d0}' \tag{12}$$

$$\dot{\Delta E_{fd}} = [-K_A (K_5 \Delta\delta + K_6 \Delta E'_q + K_V \Delta\sigma) - \Delta E_{fd}] / T_A \tag{13}$$

where,

$$K_1 = \partial P_e / \partial \delta, K_2 = \partial P_e / \partial E'_q, K_P = \partial P_e / \partial \sigma$$

$$K_3 = \partial E_q / \partial E'_q, K_4 = \partial E_q / \partial \delta, K_Q = \partial E_q / \partial \sigma$$

$$K_5 = \partial V_T / \partial \delta, K_6 = \partial V_T / \partial E'_q, K_V = \partial V_T / \partial \sigma$$

The Phillips-Heffron model of the single machine infinite bus (SMIB) system with TCSC and PSS is obtained using the linearized equations (10) – (13). The corresponding block diagram model is shown in Fig. 3 [14].

III. OVERVIEW OF PARTICLE SWARM OPTIMIZATION TECHNIQUE

The PSO method is a member of wide category of Swarm Intelligence methods for solving the optimization problems. It is a population based search algorithm where each individual is referred to as particle and represents a candidate solution. Each particle in PSO flies through the search space with an adaptable velocity that is dynamically modified according to its own flying experience and also the flying experience of the other particles. In PSO each particles strive to improve themselves by imitating traits from their successful peers. Further, each particle has a memory and hence it is capable of remembering the best position in the search space ever visited

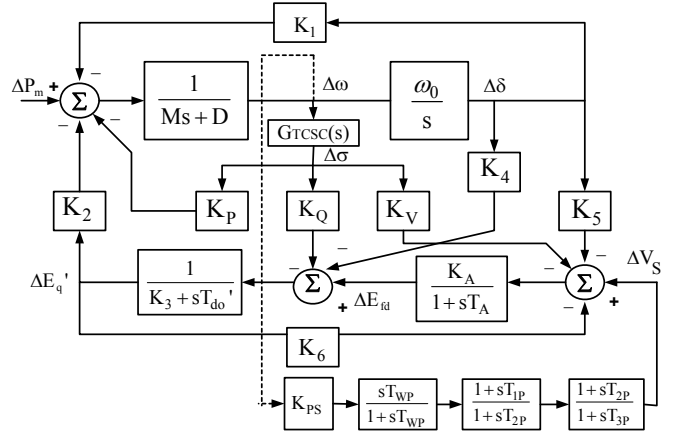

Fig. 3 The Phillips-Heffron model of SMIB with TCSC and PSS

by it. The position corresponding to the best fitness is known as pbest and the overall best out of all the particles in the population is called gbest [11] - [12]. The features of the searching procedure can be summarized as follows [15]-[16]:

- 1) Initial positions of pbest and gbest are different. However, using the different direction of pbest and gbest, all agents gradually get close to the global optimum.
- 2) The modified value of the agent position is continuous and the method can be applied to the continuous problem. However, the method can be applied to the discrete problem using grids for XY position and its velocity.
- 3) There are no inconsistency in searching procedures even if continuous and discrete state variables are utilized with continuous axes and grids for XY positions and velocities. Namely, the method can be applied to mixed integer nonlinear optimization problems with continuous and discrete state variables naturally and easily.
- 4) The above concept is explained using only XY axis (2 dimensional space). However, the method can be easily applied to n dimensional problem.

In a d-dimensional search space, the best particle updates its velocity and positions with following equations:

$$v_{id}^{n+1} = wv_{id}^n + c_1 r_1^n (P_{id}^n - x_{id}^n) + c_2 r_2^n (P_{gd}^n - x_{id}^n) \tag{14}$$

$$x_{id}^{n+1} = x_{id}^n + v_{id}^{n+1} \tag{15}$$

where,

w = inertia weight

c_1, c_2 = cognitive and social acceleration respectively

r_1, r_2 = random numbers uniformly distributed in the range (0, 1)

The i -th particle in the swarm is represented by a d -dimensional vector $X_i = (x_{i1}, x_{i2}, \dots, x_{id})$ and its velocity is denoted by another d -dimensional vector $V_i = (v_{i1}, v_{i2}, \dots, v_{id})$. The best previously visited position of the i -th particle is represented by $P_i = (p_{i1}, p_{i2}, \dots, p_{id})$.

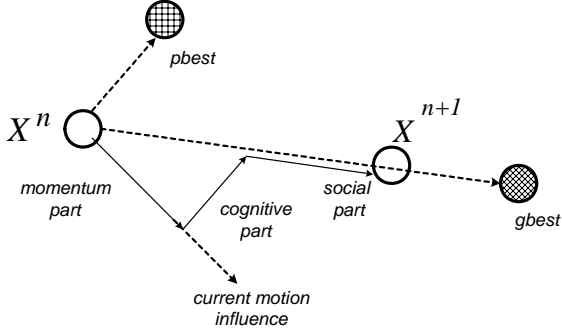

Fig. 4 Position updates of particles in particle swarm optimization technique

In PSO, each particle moves in the search space with a velocity according to its own previous best solution and its group's previous best solution. The velocity update in a PSO consists of three parts; namely momentum, cognitive and social parts. The balance among these parts determines the performance of a PSO algorithm. The parameters c_1 & c_2 determine the relative pull of p_{best} and g_{best} and the parameters r_1 & r_2 help in stochastically varying these pulls. In the above equations, superscripts denote the iteration number. Fig. 4 shows the position update of a particle for a two-dimensional parameter space.

IV. PROBLEM FORMULATION

A. PSS and TCSC Controller Structure

The commonly used lead-lag structure is chosen in this study as a PSS and TCSC controller structure. The lead-lag structure of the PSS is shown in Fig. 2. The structure of the TCSC controller is shown in Fig. 5.

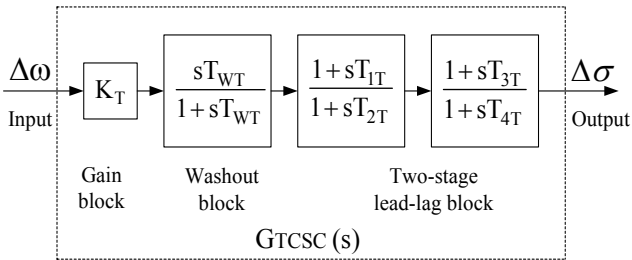

Fig. 5 Structure of the TCSC controller

It consists of a gain block with gain K_T , a signal washout block and two-stage phase compensation block as shown in figure. The phase compensation block provides the appropriate phase-lead characteristics to compensate for the phase lag between input and the output signals. The signal washout block serves as a high-pass filter, with the time constant T_{WT} , high enough to allow signals associated with

oscillations in input signal to pass unchanged. Without it steady changes in input would modify the output. From the viewpoint of the washout function, the value of T_{WT} is not critical and may be in the range of 1 to 20 seconds.

The damping torque contributed by the TCSC can be considered to be in two parts. The first part K_P , which is referred as the direct damping torque, is directly applied to the electromechanical oscillation loop of the generator. The second part K_Q and K_V , named as the indirect damping torque, applies through the field channel of the generator. The damping torque contributed by TCSC controller to the electromechanical oscillation loop of the generator is:

$$\Delta T_D = T_D \omega_0 \Delta \omega \cong K_P K_T K_D \Delta \omega$$

where, T_D is the damping torque coefficient.

The transfer functions of the PSS and the TCSC controller are:

$$U_{PSS} = K_P \left(\frac{sT_{WP}}{1+sT_{WP}} \right) \left(\frac{1+sT_{1P}}{1+sT_{2P}} \right) \left(\frac{1+sT_{3P}}{1+sT_{4P}} \right) y \quad (16)$$

$$U_{TCSC} = K_T \left(\frac{sT_{WT}}{1+sT_{WT}} \right) \left(\frac{1+sT_{1T}}{1+sT_{2T}} \right) \left(\frac{1+sT_{3T}}{1+sT_{4T}} \right) y \quad (17)$$

where, u_{TCSC} & u_{PSS} are the output signals of the TCSC controller and PSS respectively and y is the input signal to these controllers. In this structure, the washout time constants T_{WT} & T_{WP} and the time constants T_{2T} , T_{4T} , T_{2P} and T_{4P} are usually prespecified. In the present study, $T_{WT} = T_{WP} = 10s$ and $T_{2T} = T_{4T} = T_{2P} = T_{4P} = 0.1s$ are used. The controller gains K_T & K_P and the time constants T_{1T} , T_{3T} , T_{1P} , T_{3P} are to be determined. The input signal of the proposed TCSC stabilizer is the speed deviation $\Delta\omega$ and the output is change in conduction angle $\Delta\sigma$. During steady state conditions $\Delta\sigma = 0$ and $X_{Eff} = X_T + X_L - X_{TCSC}(\alpha_0)$. During dynamic conditions the series compensation is modulated for damping system oscillations. The effective reactance in dynamic conditions is: $X_{Eff} = X_T + X_L - X_{TCSC}(\alpha)$, where $\sigma = \sigma_0 + \Delta\sigma$ and $\sigma = 2(\pi - \alpha)$, α_0 and σ_0 being initial value of firing & conduction angle respectively. In case of PSS the input signal is the same speed deviation ($\Delta\omega$), and the output signal is the voltage setting V_S which is added to the excitation system reference voltage V_R .

B. Objective Function

It is worth mentioning that the PSS and TCSC controller are designed to minimize the power system oscillations after a disturbance so as to improve the stability. These oscillations are reflected in the deviations in the generator rotor speed ($\Delta\omega$). In the present study the objective function J is formulated as the minimization of:

$$J = \sum \int_0^t t [\Delta\omega(t, X)]^2 dt \quad (18)$$

In the above equations, $\Delta\omega(t, X)$ denotes the rotor speed

deviation for a set of controller parameters X (note that here X represents the parameters to be optimized; $K_T, K_{PS}, T_{1T}, T_{3T}, T_{1P}, T_{3P}$; the parameters of TCSC and PSS controller), and t_1 is the time range of the simulation. With the variation of the parameters X, the $\Delta\omega(t, X)$ will also be changed. For objective function calculation, the time-domain simulation of the power system model is carried out for the simulation period. It is aimed to minimize this objective function in order to improve the system response in terms of the settling time and overshoots.

C. Application of Particle Swarm Optimization Technique

Tuning a controller parameter can be viewed as an optimization problem in multi-modal space as many settings of the controller could be yielding good performance. Traditional method of tuning doesn't guarantee optimal parameters and in most cases the tuned parameters needs improvement through trial and error. In PSO based method, the tuning process is associated with an optimality concept through the defined objective function and the time domain simulation. Hence the PSO methods yield optimal parameters and the method is free from the curse of local optimality [17]. In view of the above, the proposed approach employs PSO to solve this optimization problem and search for optimal set of the PSS and TCSC Controller parameters. The designer has the freedom to explicitly specify the required performance objectives in terms of time domain bounds on the closed loop responses.

For the purpose of optimization of (18), routines from PSO toolbox are used [18]. The objective function is evaluated for each individual by simulating the system dynamic model considering a 5% step increase in mechanical power input (ΔP_m) at $t = 1.0$ sec. The objective function J comes from time domain simulation of the power system model shown in Fig. 3. J attains a finite value since the deviation in rotor angle is regulated to zero. The computational flow chart of PSO algorithm is shown in Fig. 6. While applying PSO, a number of parameters are required to be specified. An appropriate choice of the parameters affects the speed of convergence of the algorithm. Optimization is terminated by the prespecified number of generations. The optimization was performed with the total number of generations set to 200 with a swarm size of 20. The convergence rate of objective function J for 'gbest' with the number of generations is shown in Fig. 7. The figure shows the convergence rate of objective function J for gbest, when the PSS and TCSC controllers are designed individually and through coordinated design approach. The minimization of objective function with the number of generation for individual PSS and individual TCSC are shown in Fig. 7 with legends PSS and TCSC respectively; and the same with coordinated design is shown with legend PSS and TCSC. It is clear from the figure that the minimization of the objective function with coordinated design approach is maximum compared to that of the individual design one. The movement of particles towards the gbest in a PSO algorithm is shown in Fig. 8, where the position of gbest is shown with a circle mark. Table I shows the optimal values of PSOPSS and PSOTCSC

controller parameters obtained by the individual and coordinated design approach employing PSO algorithm.

TABLE I
OPTIMIZED PARAMETERS SETTINGS OF THE PROPOSED CONTROLLERS

Parameters	Individual design		Coordinated design	
	PSOPSS	PSOTCSC	PSOPSS	PSOTCSC
K	14.6863	31.5945	33.1288	42.5333
T_1	0.5677	0.1098	0.2033	0.145
T_2	0.1	0.1	0.1	0.1
T_3	0.1186	0.2942	0.1467	0.3976
T_4	0.1	0.1	0.1	0.1

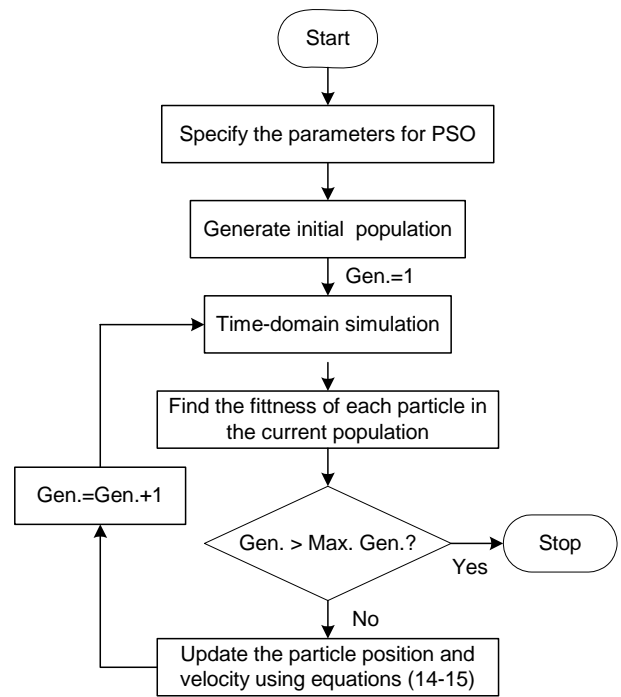

Fig. 6 Flow chart of particle swarm optimization algorithm

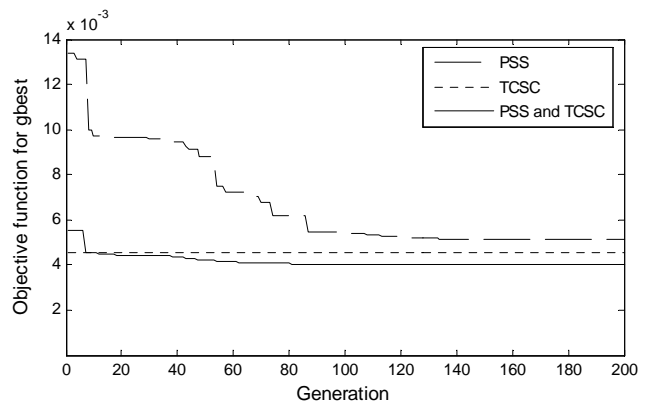

Fig. 7 Convergence of objective function for gbest

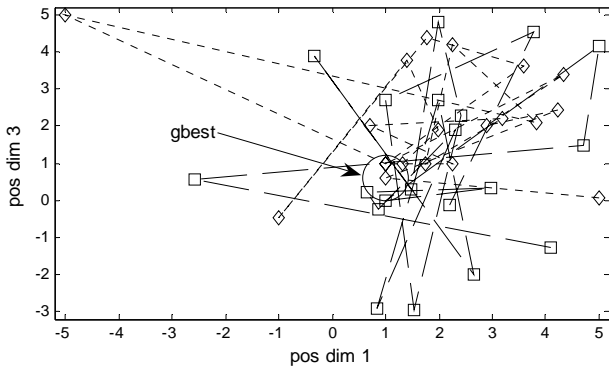

Fig. 8 Movement of particle towards gbest in the PSO algorithm

V. SIMULATION RESULTS

To evaluate the capability of the PSS and TCSC controller on damping electromechanical oscillations of the electric power system, simulations on the SMIB system are performed. The system eigenvalues without and with the proposed controllers are given in Table II. It is clear that the open loop system is unstable because of the negative damping of electromechanical mode. With CPSS [9], the system stability is maintained as the electromechanical mode eigenvalue shift to the left of the line in *s*-plane ($s = -0.9275$). It is also clear that PSOPSS outperform the CPSS and shifts substantially the electromechanical mode eigenvalue to the left of the line $s = -1.3939$ in the *s*-plane, which enhances the system stability and improves the damping characteristics of electromechanical mode. The shift in electromechanical mode eigenvalue to the left of the line in the *s*-plane is more ($s = -1.4134$) with PSOTCSC. With the coordinated design approach, maximum shift occurs in the electromechanical mode eigenvalue to the left of the line ($s = -1.5859$) in the *s*-plane. Hence the system stability and damping characteristics greatly improve with the coordinated design approach.

TABLE II
SYSTEM EIGENVALUE WITHOUT AND WITH CONTROL
(INDIVIDUAL AND COORDINATED DESIGN)

Without control	CPSS only	PSOPSS only	PSOTCSC only	Coordinated design
$0.3398 \pm 4.9480i$	$-0.9275 \pm 4.6664i$	$-1.3939 \pm 3.773i$	$-1.4134 \pm 3.2832i$	$-1.5859 \pm 2.0034i$
$-10.3755 \pm 3.1733i$	$-5.0747 \pm 6.6952i$	$-3.9464 \pm 9.2047i$	$-8.54485 \pm 5.775i$	$-8.3389 \pm 8.6479i$
-	-18.0666	-20.9171	-22.8766	-41.6516
-	-10	-8.4731	-9.1401	-10
-	-0.1003	-0.1007	-0.1019	-0.1044
-	-	-	-	-7.0698
-	-	-	-	-0.1

In order to verify the effectiveness of the optimized controllers, the performance of the PSOPSS and PSOTCSC controller is tested for a disturbance in mechanical power input. A 5 % step increase in mechanical power input at $t=1.0$ sec is considered. The system response for the above contingency is shown in Fig. 9. The response of the proposed schemes is compared to that of CPSS given in Ref. [9]. In the

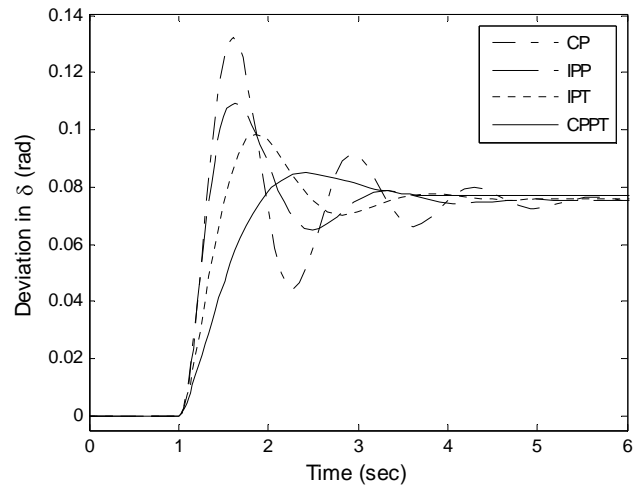

(a)

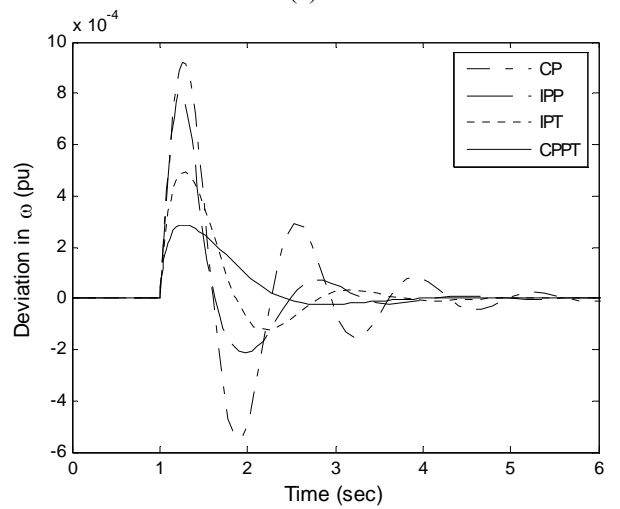

(b)

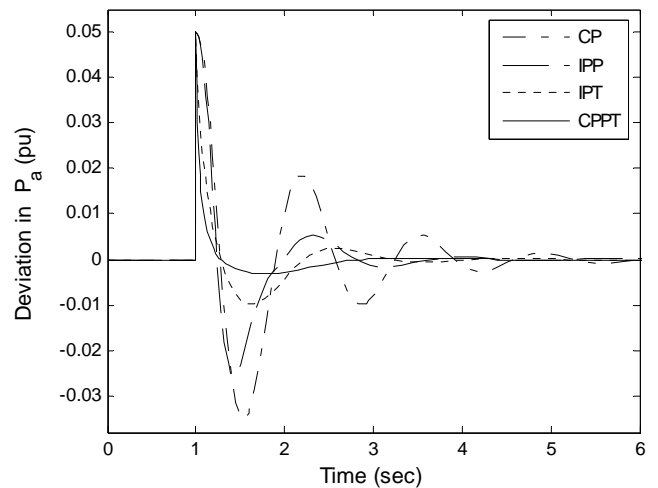

(c)

Fig. 9 System response for a 5 % step increase in mechanical power input (a) power angle δ (b) speed ω (c) accelerating power P_a

Fig. 9, the response with conventional power system stabilizer (CPSS), individual design of proposed PSOPSS and individual design of proposed PSOTCSC are shown with legends CP,

IPP and IPT respectively; the coordinated design of PSOPSS & PSOTCSC is shown with legend CPPT. It is clear that PSOPSS outperforms the CPSS in terms of overshoot and settling time. It is also clear that the system response with the proposed PSOTCSC is better than that with the PSOPSS. Further, it can be seen from the figure that the coordinated design of PSOPSS & PSOTCSC gives the best response in terms of overshoot and settling time. The first swing in the δ , ω and P_a is significantly suppressed and the settling time is greatly reduced with the coordinated design approach.

The deviations in the stabilizing signal of PSS (V_S) and the conduction angle ($\Delta\sigma$) of TCSC controller when designed individually and in coordinated manner are also compared and shown in Figs. 10 and 11 respectively. It is clear that the coordinated design schemes outperform the CPSS and the control efforts are significantly reduced. This confirms the potential of the coordinated approach for ultimate utilization of the control schemes to enhance the system dynamic stability.

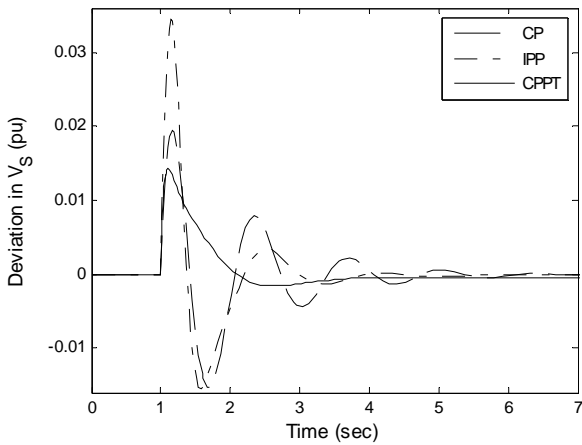

Fig. 10 Deviation in stabilizing signal of PSS for a 5 % step increase in mechanical power input

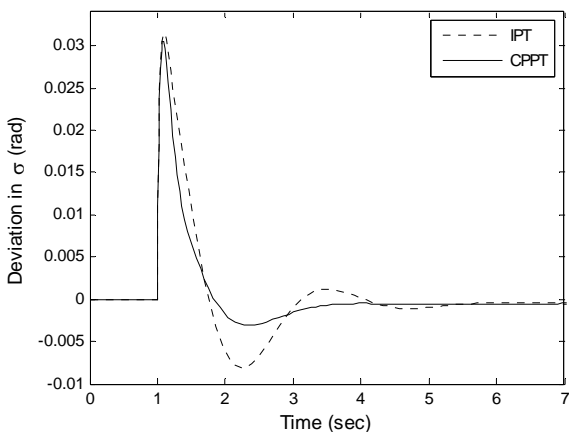

Fig. 11 Deviation in conduction angle of TCSC for a 5 % step increase in mechanical power input

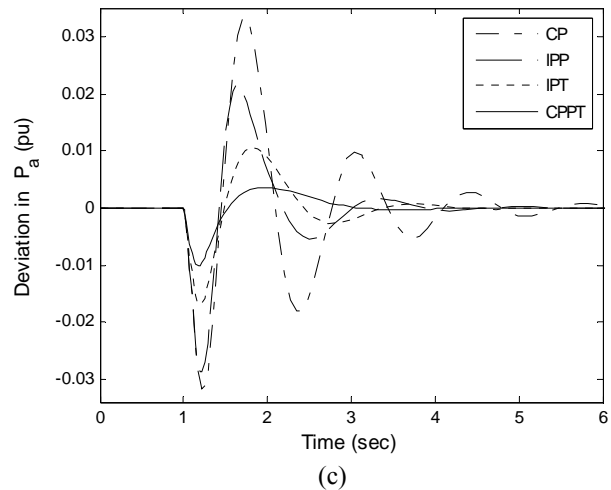
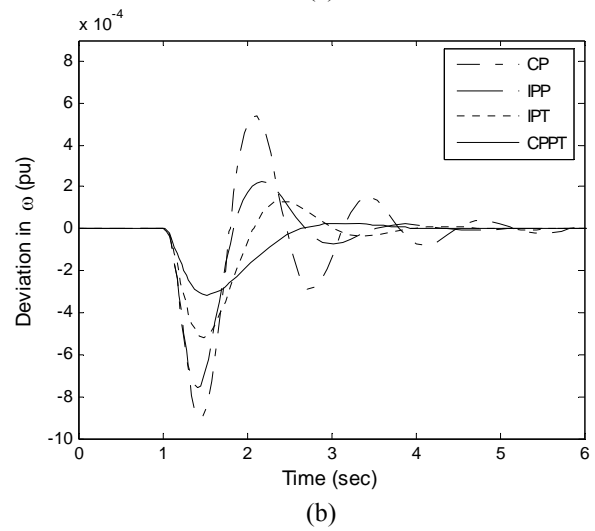
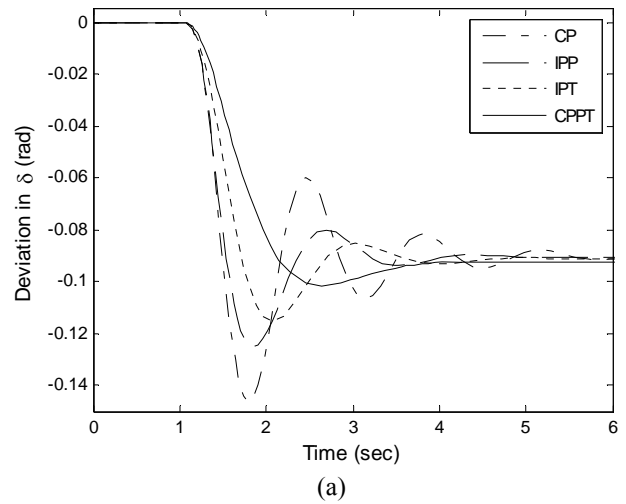

Fig. 12 System response for a 5 % step increase in reference voltage setting (a) power angle δ (b) speed ω (c) accelerating power P_a

For completeness, the effectiveness of the proposed controllers is also tested for a disturbance in reference voltage setting. The reference voltage setting is increased by a step of 5% at $t=1$ sec. Fig. 12 shows the system response for the

above contingency. The figure illustrates the advantage of coordinated design approach over the individual design approach. These positive results of the coordinated design approach can be attributed to its faster response compared to that of individual approach. The coordinated design approach has good damping characteristics to low frequency oscillations and stabilizes the system much faster. This extends the power system stability limit and the power transfer capability.

The stabilizing signal of PSS (V_S) and the deviation in the conduction angle ($\Delta\sigma$) of TCSC controller when designed individually and in coordinated manner are compared and shown in Figs. 13 and 14 respectively. It is clear that the coordinated design schemes outperform the CPSS and the control efforts are significantly reduced. This confirms the potential of the coordinated approach for ultimate utilization of the control schemes to enhance the system dynamic stability.

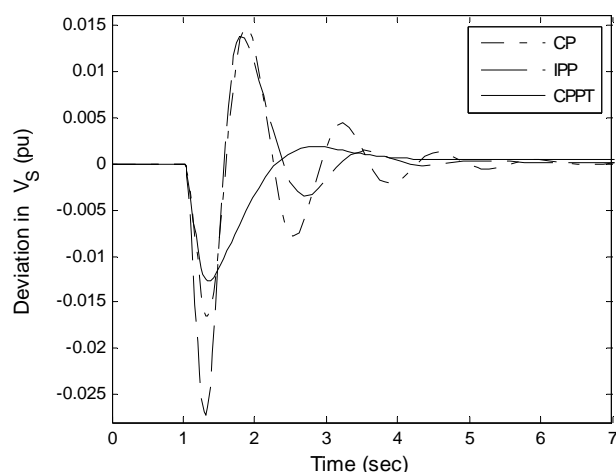

Fig. 13 Deviation in stabilizing signal of PSS for a 5 % step increase in reference voltage setting

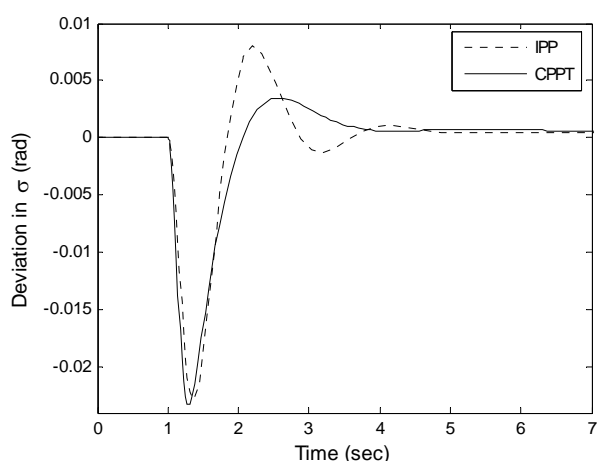

Fig. 14 Deviation in conduction angle of TCSC for a 5 % step increase in reference voltage setting

VI. CONCLUSION

In this study, the power system stability enhancement by coordinated design of PSS and TCSC-based controllers is presented and discussed. The coordinated design problem of PSS and TCSC-based controller is formulated as an optimization problem and Particle Swarm Optimization technique is employed to search for the optimal controller parameters. The controllers are designed; both individually and in a coordinated manner and their performances are compared with the conventional power system stabilizer. The controllers are tested on weakly connected power system subjected to different disturbances. The simulation results show the effectiveness of the coordinated design approach over individual design of controllers. Further, it is observed that the control efforts are significantly reduced when designed in a coordinated manner compared to the individual design, which confirms the potential of the coordinated approach for ultimate utilization of the control schemes to enhance the system dynamic stability.

APPENDIX

System data: All data are in pu unless specified otherwise.

Generator: $H = 4.0$ s., $D = 0$, $X_d = 1.0$, $X_q = 0.6$, $X_d' = 0.3$, $T_{d0}' = 5.044$, $f = 50$, $R_a = 0$, $P_e = 1.0$, $Q_e = 0.303$, $\delta_0 = 60.62^\circ$.

Exciter : (IEEE Type ST1): $K_A = 200$, $T_A = 0.04$ s.

Transmission line and Transformer: $(X_L = 0.7, X_T = 0.1) = 0.0 + j0.7$

TCSC Controller: $X_{TCSC0} = 0.245$, $\alpha_0 = 156.04^\circ$, $X_C = 0.21$, $X_P = 0.0525$

REFERENCES

- [1] P. Kundur, *Power System Stability and Control*. New York: McGraw-Hill, 1994.
- [2] N. G. Hingorani and L. Gyugyi, *Understanding FACTS: Concepts and Technology of Flexible AC Transmission System*. IEEE Press, 2000.
- [3] P. Mattavelli, G. C. Verghese and A. M. Stankovitch, "Phasor dynamics of Thyristor-Controlled series capacitor systems," *IEEE Trans. Power Sys.*, vol-12, pp. 1259-1267, 1997.
- [4] B. H Li, Q. H. Wu, D. R. Turner, P. Y. Wang and X.X Zhou, "Modeling of TCSC dynamics for control and analysis of power system stability," *Electrical Power & Energy Sys.*, Vol-22, pp. 43-49, 2000.
- [5] L. Fan, A. Feliachi and K. Schoder, "Selection and design of a TCSC control signal in damping power system inter-area oscillations for multiple operating conditions," *Electrical Power & Energy Sys.*, vol-62, pp. 127-137, 2002.
- [6] A. D Del Rosso, C. A Canizares and V.M. Dona, "A study of TCSC controller design for power system stability improvement," *IEEE Trans. Power Sys.*, vol-18, pp. 1487-1496, 2003.
- [7] J.J. Sanchez-Gasca and J. H Chow, "Power system reduction to simplify the design of damping controllers for inter-area oscillations," *IEEE Trans. Power Sys.*, vol-11, pp. 1342-1349, 1996.
- [8] P. Pourbeik and M. J. Gibbard, "Simultaneous coordination of power-system stabilizers and FACTS device stabilizers in a multimachine power system for enhancing dynamic performance," *IEEE Trans. Power Sys.*, vol-13, pp. 473-479, 1998.
- [9] Yao-Nan Yu, *Power System Dynamics*, Academic press Inc., London, 1983.
- [10] M. A. Abido, "Pole placement technique for PSS and TCSC-based stabilizer design using simulated annealing" *Electrical Power and Energy Systems*, vol-22, pp 543-554, 2000.

- [11] Kennedy, J. and Eberhart, R.C. (1995). Particle swarm optimization. Proc. IEEE Int'l. Conf. on Neural Networks, IV, 1942-1948. Piscataway, NJ: IEEE Service Center. Available: <http://www.engr.iupui.edu/~shi/Coference/psopap4.html>
- [12] PSO Tutorial, <http://www.swarmintelligence.org/tutorials.php>
- [13] K. R. Padiyar, *Power System Dynamics: Stability and Control*, 2nd edition, BS Pub., Hyderabad, India, 2002.
- [14] H.F.Wang and F.J.Swift, "A unified model for the analysis of FACTS devices in damping power system oscillations part I: single-machine infinite-bus power systems," IEEE Trans. Power Delivery, vol. 12, no. 2, pp. 941-946, 1997.
- [15] Kennedy, J., Eberhart, R.C., Shi, Y. "Swarm Intelligence". San Francisco: Morgan Kaufmann Publishers, 2001.
- [16] Clarc, M., Kennedy, J. "The particle swarm – explosion, stability, and convergence in a multidimensional complex space". IEEE Transactions on Evolutionary Computation. pp. 58-73. 2002.
- [17] Gaing, Z.L. "A particle swarm optimization approach for optimum design of PID controller in AVR system". IEEE Trans. Energy Conv. Vol. 9, No. 2, pp. 384-391, June2004.
- [18] Birge, B. "Particle Swarm Optimization Toolbox". Available: <http://www.mathworks.com/matlabcentral/fileexchange/>

Sidhartha Panda received the M.E. degree in Power Systems Engineering from University College of Engineering, Burla, Sambalpur University, India in 2001. Currently, he is a Research Scholar in Electrical Engineering Department of Indian Institute of Technology Roorkee, India. He was an Associate Professor in the Department of Electrical and Electronics Engineering, VITAM College of Engineering, Andhra Pradesh, India and Lecturer in the Department of Electrical Engineering, SMIT, Orissa, India. His areas of research include power system transient stability, power system dynamic stability, FACTS, optimization techniques, distributed generation and wind energy.

Narayana Prasad Padhy was born in India and received his Degree (Electrical Engineering), Masters Degree (Power Systems Engineering) with Distinction and Ph.D., Degree (Power Systems Engineering) in the year 1990, 1993 and 1997 respectively in India. Then he has joined the Department of Electrical Engineering, Indian Institute of Technology (IIT) India, as a Lecturer, Assistant Professor and Associate Professor during 1998, 2001 and 2006 respectively. Presently he is working as a Associate Professor in the Department of Electrical Engineering, Indian Institute of Technology (IIT) India. He has visited the Department of Electronics and Electrical Engineering, University of Bath, UK under Boyscast Fellowship during 2005-06. His area of research interest is mainly Power System Privatization, Restructuring and Deregulation, Transmission and Distribution network charging, Artificial Intelligence Applications to Power System and FACTS.

این مقاله، از سری مقالات ترجمه شده رایگان سایت ترجمه فا میباشد که با فرمت PDF در اختیار شما عزیزان قرار گرفته است. در صورت تمایل میتوانید با کلیک بر روی دکمه های زیر از سایر مقالات نیز استفاده نمایید:

لیست مقالات ترجمه شده ✓

لیست مقالات ترجمه شده رایگان ✓

لیست جدیدترین مقالات انگلیسی ISI ✓

سایت ترجمه فا ؛ مرجع جدیدترین مقالات ترجمه شده از نشریات معتبر خارجی